



Columbia

Product Catalogue



COMFORT GRIP PUTTY KNIVES

Columbia Tools proudly presents the Comfort Grip Putty Knives, designed for all-day comfort and professional performance. Featuring a rubberized handle for maximum control and a high-quality stainless steel blade, these knives provide the smooth flexibility and durability expected by professionals.

Item No.	Description
CGPK1.5	1.5" Comfort Grip Putty Knife
CGPK2	2" Comfort Grip Putty Knife
CGPK3	3" Comfort Grip Putty Knife
CGPK4	4" Comfort Grip Putty Knife
CGPK5	5" Comfort Grip Putty Knife
CGPK6	6" Comfort Grip Putty Knife
CGPK8	8" Comfort Grip Putty Knife
CGPK10	10" Comfort Grip Putty Knife
CGCK3.5	3.5" Comfort Grip Pointing Joint Knife
CGCK6	6" Comfort Grip Clipped Joint Knife
91CGMT	9-1 Comfort Grip Multi Tool
3CGPK4	4" Three-Way Comfort Grip Putty Knife
3CGPK5	5" Three-Way Comfort Grip Putty Knife
3CGPK6	6" Three-Way Comfort Grip Putty Knife

THREE-WAY COMFORT GRIP PUTTY KNIVES

The new Three-Way Comfort Grip Putty Knives provide faster and cleaner corner finishing.

They feature a Comfort Grip handle, built-in hammerhead, and stainless steel construction, with a tapered blade design that protects knuckles and minimizes grooves. Available in 4", 5" & 6" sizes for common applications.



JOINT KNIFE BLISTER PACKS

A convenient 3-piece set featuring 4", 5" and 6" Comfort Grip Putty Knives — the essential sizes for everyday drywall finishing. Packaged for easy retail display and quick grab-and-go purchase. Available in regular Comfort Grip Putty Knives and Three-Way Comfort Grip Putty Knives.

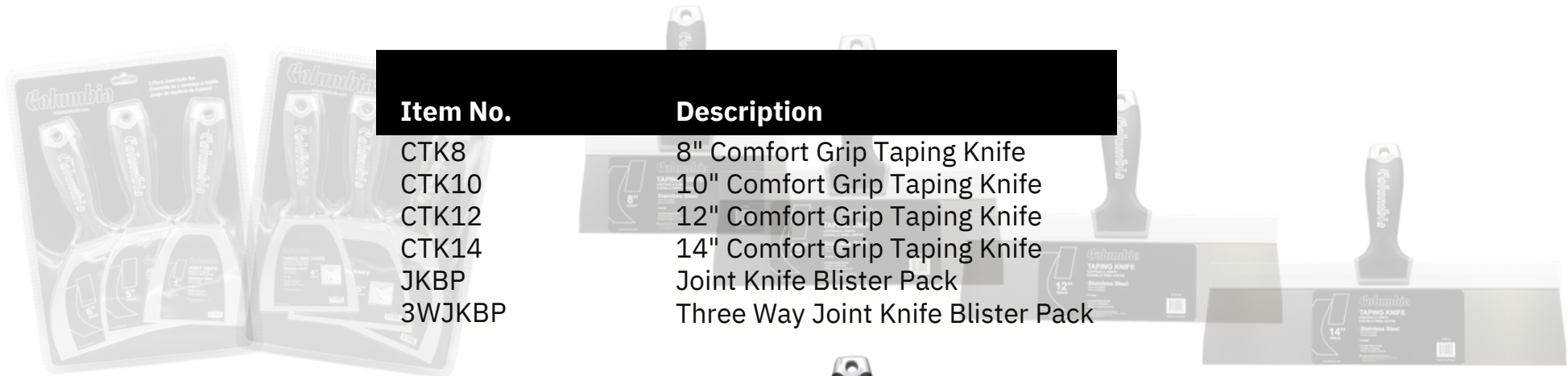

Item No.

Description

CTK8	8" Comfort Grip Taping Knife
CTK10	10" Comfort Grip Taping Knife
CTK12	12" Comfort Grip Taping Knife
CTK14	14" Comfort Grip Taping Knife
JKBP	Joint Knife Blister Pack
3WJKBP	Three Way Joint Knife Blister Pack

COMFORT GRIP TAPING KNIVES

The Comfort Grip Taping Knives, designed specifically for professionals seeking speed, precision, comfort and durability in every task. The rubberized comfort grip handle is expertly shaped to provide maximum control and minimal strain, ensuring the utmost comfort during use.

STAINLESS STEEL BLADE

HAMMER HEAD



NYLON PUTTY KNIVES

Designed for exceptional drywall finishing. They feature a premium Stainless Steel blade for durability, flexibility for smooth finishes and a nylon handle with a hammer head for added strength. Ideal for professionals, these knives ensure high performance and a flawless finish.

Item No.	Description
NPK1.5	1.5" Nylon Putty Knife
NPK2	2" Nylon Putty Knife
NPK3	3" Nylon Putty Knife
NPK4	4" Nylon Putty Knife
NPK5	5" Nylon Putty Knife
NPK6	6" Nylon Putty Knife
NPK8	8" Nylon Putty Knife
NPK10	10" Nylon Putty Knife
PJK3.5	3.5" Pointing Joint Knife
CJK6	6" Clipped Joint Knife
9-1MT	9 In 1 Multi Tool
3NPK4	4" Three-Way Nylon Handle Putty Knife
3NPK5	5" Three-Way Nylon Handle Putty Knife
3NPK6	6" Three-Way Nylon Handle Putty Knife

HAMMER HEAD



Three Way Knife

THREE WAY KNIVES

These knives enhance our Stainless Steel Nylon Handle Putty Knives by refining the blade shape for three-way corners. With a higher arch and inward taper, they prevent interference with the wall, ensuring smooth, precise finishes.

STAINLESS STEEL BLADE



ONE PIECE PUTTY KNIVES

Columbia One Piece Putty Knives are crafted from a single piece of stainless steel with welded construction, ensuring durability and flexibility. The one-piece design maximizes strength and reliability, while the flexible blade provides a smooth application for finishing. An ergonomic grip promotes comfort and control while reducing strain. These knives are corrosion-resistant, making them durable and easy to clean.



STAINLESS STEEL



Item No.	Description
----------	-------------

- | | |
|----------|---|
| OPPK1.5 | 1.5" One Piece Putty Knife |
| OPPK2 | 2" One Piece Putty Knife |
| OPPK3 | 3" One Piece Putty Knife |
| OPPK4 | 4" One Piece Putty Knife |
| OPPK5 | 5" One Piece Putty Knife |
| OPPK6 | 6" One Piece Putty Knife |
| OPPK8 | 8" One Piece Putty Knife |
| OPPK10-1 | 10-1 One Piece Multi Tool |
| OPBS | 6" One Piece Bucket Scoop (stainless steel) |

ONE PIECE PUTTY KNIFE SET

Introducing the Columbia One-Piece Putty Knife Set, this high quality knife set now comes in a highly durable case to offer you piece of mind when storing your knives when not in use. Set includes OPPK3,4,5,6,8,10-1 & OPBS.

Item No.	Description
----------	-------------

- | | |
|--------|---------------------------|
| OPKSET | One Piece Putty Knife Set |
|--------|---------------------------|



FREE GRIP

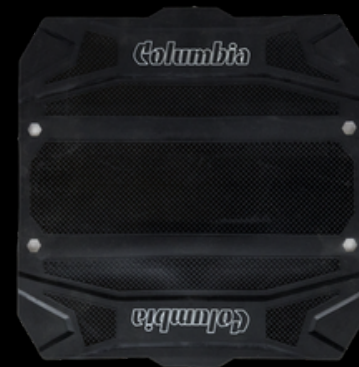

LIFETIME WARRANTY

STAINLESS STEEL MUD PANS

LIFETIME WARRANTY

Columbia Tools introduces the Columbia Mud Pan, designed for professionals who prioritize durability, comfort and performance. Made from heavy-gauge stainless steel with watertight, laser-welded seams, it's built to handle tough jobs and offer long-lasting reliability. The round corners make it easy to clean mud out, while the tapered ends and sides ensure a secure grip. The included free non-slip rubber grip provides added comfort. Available in 12", 14" and 16" sizes and sold in packs of 6, the Columbia Mud Pan is backed by a lifetime warranty and engineered for strength, efficiency and ease of use.

Item No.

Description

C12MPX6

12" STAINLESS MUD PAN

C14MPX6

14" STAINLESS MUD PAN

C16MPX6

16" STAINLESS MUD PAN

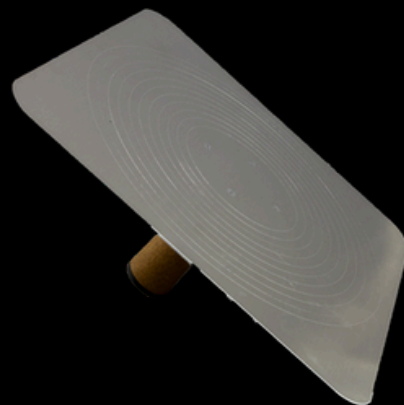
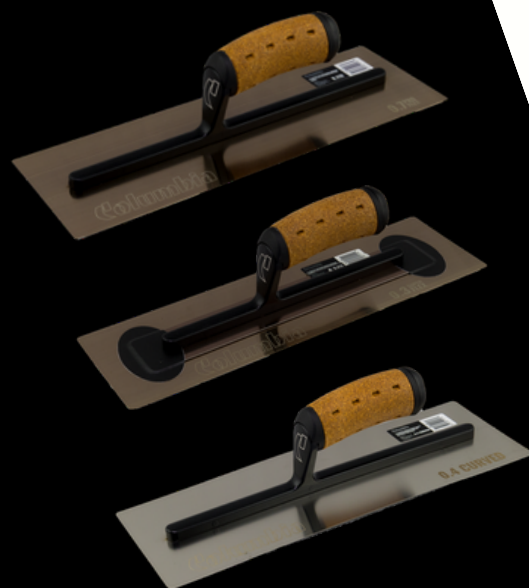

PREMIUM HAWK & TROWELS

Columbia's Premium Finishing Hawk and Trowels are designed for professionals who require flexibility, strength and control. Our trowels feature hardened Stainless-Steel blades, rounded corners and ergonomic cork handles. Available in Pro-Flex Gold (12", 14", 16", 18"), Curved Gold (12", 14", 16"), Curved Silver (12", 14"), and Super-Flex Gold (12", 14") sizes.

The 13" Finishing Hawk ensures smooth gliding with a high-quality aluminum plate, round corners and a comfortable cork handle with a rubber cover.

Item No.

Description

12-4.7-0.7-G-C	12" GOLD FINISHING TROWEL
14-4.7-0.7-G-C	14" GOLD FINISHING TROWEL
16-4.7-0.7-G-C	16" GOLD FINISHING TROWEL
18-4.7-0.7-G-C	18" GOLD FINISHING TROWEL
12-4.7-0.7-G-C-C	12" GOLD CURVE TROWEL
14-4.7-0.7-G-C-C	14" GOLD CURVE TROWEL
16-4.7-0.7-G-C-C	16" GOLD CURVE TROWEL
12-4.7-0.4-S-C-C	12" SILVER CURVE TROWEL
14-4.7-0.4-S-C-C	14" SILVER CURVE TROWEL
12-4.3-0.3-G-C	12" GOLD FINISHING TROWEL .3MM
14-4.3-0.3-G-C	14" GOLD FINISHING TROWEL .3MM
13-H-S	13" X 13" HAWK

MUD ROLLERS

Columbia 2K Handle Mud Rollers are built for speed, comfort and versatility. The ergonomic grip with thumb rest provides better control and reduces fatigue. A quick-connect system attaches to Columbia Fiberglass Extension Handles or use the Universal Thread Adapter for standard paint poles. Roll your mud with confidence using our premium Mud Rollers.

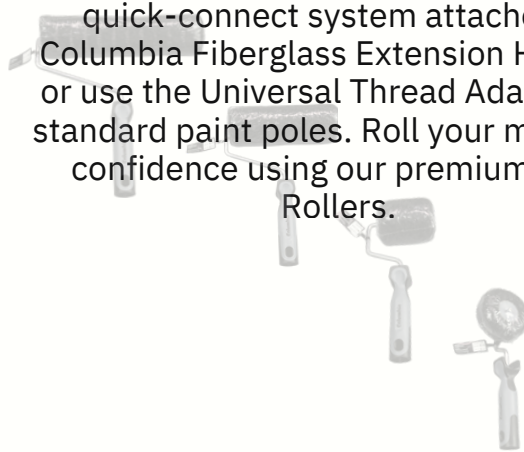

Fiberglass Extension Handle

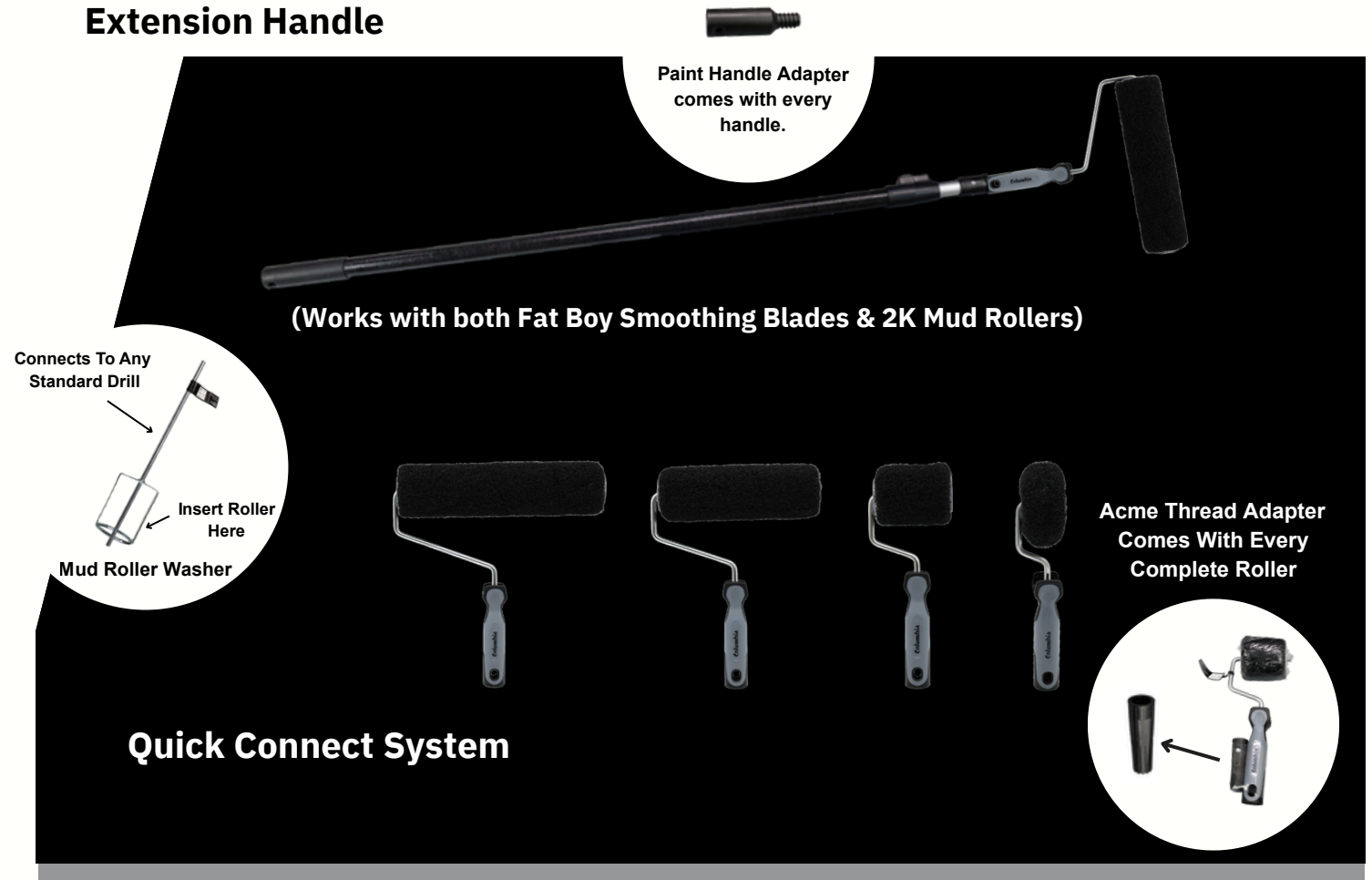

Item No.	Description
2KMR4	4"x18MM Mud Roller with 2K Quick Connect Frame
2KMR9	9"x18MM Mud Roller with 2K Quick Connect Frame
2KMR12	12"x18MM Mud Roller with 2K Quick Connect Frame
2KCMR	1.5"x18MM Corner Mud Roller with 2K Quick Connect Frame
MRR4	4"x18MM Mud Roller Replacement
MRR9	9"x18MM Mud Roller Replacement
MRR12	12"x18MM Mud Roller Replacement
CMRR	1.5"x18MM Corner Mud Roller Replacement
MRW	Mud Roller Washer
UTA	Universal Thread Adapter

- Ergonomic Grip with Thumb Spot: Comfort and control in your hand.
- Quick-Connect System: Snaps onto Fiberglass Extension Handles.
- Universal Thread Adapter: Works with any paint pole.
- High-Resilience Fibers: Advanced fibers for uniform application and release.
- Easy to Clean: Easy cleaning with the Mud Roller Washer.

FAT BOY SMOOTHING BLADES

Columbia Fat Boy Smoothing Blades are designed for comfort, precision, and performance. The lightweight, rubberized ergonomic grip provides secure handling and better control for smooth, even finishes. A replaceable Stainless-Steel blade ensures long-lasting durability. This product is great for those looking for a light weight smoothing blade that provides a professional finish.

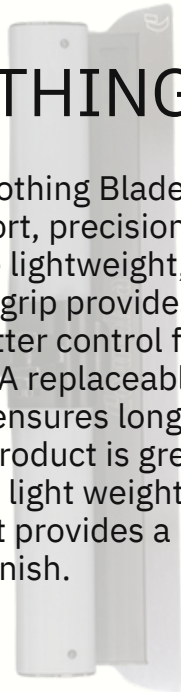

Rubberized Grip

Replaceable Stainless Steel Blades

Fat Boy Smoothing Blade Claw

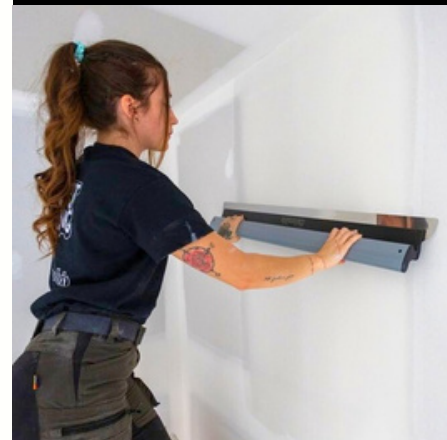

Item No.	Description
FSB7	Fat Boy Smoothing Blade 7"
FSB10	Fat Boy Smoothing Blade 10"
FSB12	Fat Boy Smoothing Blade 12"
FSB16	Fat Boy Smoothing Blade 16"
FSB18	Fat Boy Smoothing Blade 18"
FSB24	Fat Boy Smoothing Blade 24"
FSB32	Fat Boy Smoothing Blade 32"
FSB40	Fat Boy Smoothing Blade 40"
FSB48	Fat Boy Smoothing Blade 48"
FSBC	Fat Boy Smoothing Blade Claw
FTH4-6	Fiberglass Extension Pole 4'-6'
FTH5-8	Fiberglass Extension Pole 5'-8'

Tomahawk

SMOOTHING BLADES

Made of strong billet aluminum, the Columbia Tomahawk Smoothing Blades have no plastic parts that will break or crack under the heavy weight of the larger blades. This makes the Tomahawk blades the strongest and most durable on the market today. The blades are replaceable and can be switched out if needed. The Tomahawk blades are compatible with all flat box handles or use the Tomalock adapter (CLTHA) that fits the Columbia One handles, as well as the Twist Lock handle.

*Available in 9 different sizes



The CLTHA fits on the Columbia One or the Twist Lock handles.



Item No.

Description

TSB-7	7" Tomahawk
TSB-10	10" Tomahawk
TSB-12	12" Tomahawk
TSB-14	14" Tomahawk
TSB-18	18" Tomahawk
TSB-24	24" Tomahawk
TSB-32	32" Tomahawk
TSB-40	40" Tomahawk
TSB-48	48" Tomahawk
CLTHA	Tomalock Adapter



GET SOCIAL:
@columbiatools

Predator

THE FAMILY IS EXPANDING

Columbia was the first to introduce Carbon Fiber into the Taping Tool market with the Predator Automatic Taper in 2018. We are proud to introduce new additions to the Predator family. These tools are handmade from Carbon Fiber which makes them significantly lighter, stronger & dent proof while remaining warm to the touch.

Item No.

Description

PHMP	Predator Mud Pump
PCLT42	Predator Camlock Tube 42"
PCMT42	Predator Compound Tube 42"
PC1HEXT	Predator Extendable 3'-5'
PC1H	Predator One Handle 4'
PCHXL	Predator Long Extendable 4'-8'
PMHS	Predator Matrix Handle Short 29"-39"
PMH	Predator Matrix Handle 40"-60"
PMHL	Predator Matrix Handle Long 56" -76"

Predator

10



CARBON FIBER

- Handmade from Carbon Fiber
- Significantly lighter
- Dent proof/high stiffness and strength
- Stable temperature and remains warm to the touch
- Additional grip compared to aluminium

COLUMBIA FAMILY OF SETS

Our new family of tool sets makes it easy to move from hand taping to semi-automatic tools, or even fully automatic tools. These sets take the guess work out of purchasing what you need to completely finish a job.

Each set comes complete with a Columbia case to protect and store your investment, all while making it easy to travel from worksite to worksite. Columbia Sets are another way we are making taping tools easy.

Item No.	Description
TS	Tactical Set
PTS	Predator Tactical Set
SACS	Commando Set
TWS	Warrior Set
FSBSET	Fat Boy Smoothing Blade Set
MRSET	Mud Roller Set

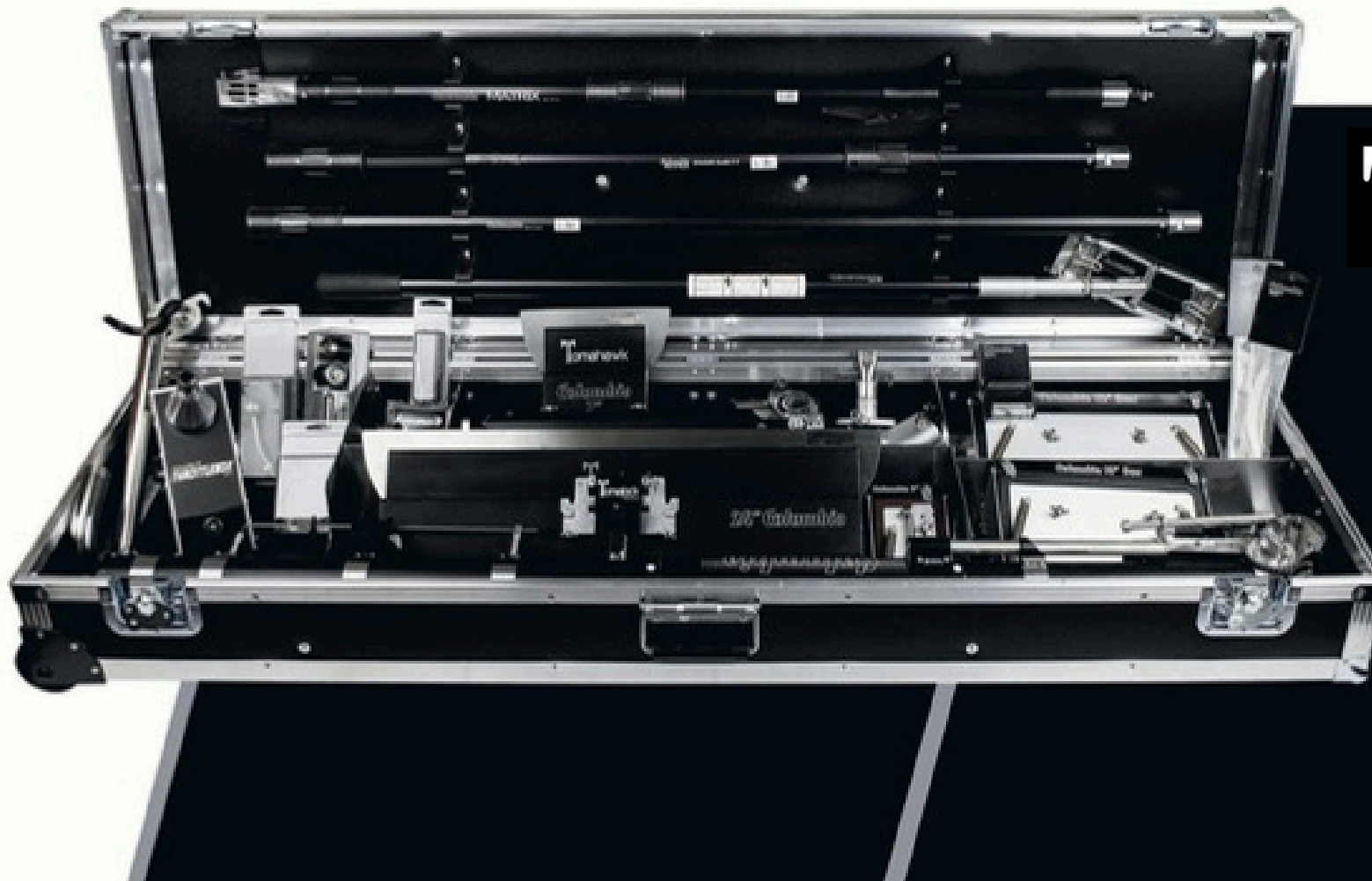

Columbia TACTICAL SET

Road Case
 Automatic Taper
 10" Flat Box
 12" Flat Box
 Matrix Handle
 7" Tomahawk
 24" Tomahawk
 8" Throttle Box
 3" Angle Head
 Hot Mud Pump
 Box Filler & Gooseneck
 Corner Roller
 3" Nail Spotter
 Columbia One Handle
 Columbia One EXT
 Sander Head
 Twist Lock Handle
 Tomalock Adapter
 Repair Kits: AH-RK,
 FFBR9-10, FFBR9-12,
 FFBR7-7A, CTR-1
 AHA
 3-Way 3 Piece Joint Knife Set



Columbia COMMANDO SEMI-AUTOMATIC SET

Semi Automatic Case
2.5" Standard Flusher
3" Standard Flusher
42" Compound Mud Tube
Columbia One Extendible Handle – 3'-5'
Columbia One 4' Fixed Handle
Angle Head Adapter
Flat Applicator
Two-Way Internal Applicator
Corner Roller



Columbia WARRIOR TOMAHAWK FINISHING SET

Semi Automatic Case
7" Tomahawk
12" Tomahawk
18" Tomahawk
32" Tomahawk
Tomalock Adapter
Columbia One EXT Handle
3-Way 3 Piece Joint Knife Set



Fat Boy Smoothing Blade Set

Semi Automatic Case
Fat Boy Smoothing Blade 7"
Fat Boy Smoothing Blade 14"
Fat Boy Smoothing Blade 18"
Fat Boy Smoothing Blade 32"
9 In 1 Multi Tool
9"x18MM Mud Roller with 2K Quick
Connect Frame
3-Way 3 Piece Joint Knife Set
4-6' Fiberglass Extension Handle
Fat Boy Smoothing Blade Claw



Mud Roller Set

Mud Roller Case
9"x18MM Mud Roller with 2K Quick
Connect Frame
4"x18MM Mud Roller with 2K Quick
Connect Frame
1.5"x18MM Corner Mud Roller with
2K Quick Connect Frame
9 In 1 Multi Tool
5" Three-Way Nylon Handle Putty Knife
6" Three-Way Nylon Handle Putty Knife
Fat Boy Smoothing Blade 24"
29-52" Extension handle
Fat Boy Smoothing Blade Claw

Predator

The Columbia One Predator Taper is designed for ultimate versatility and convenience. It's removable head features quick-release draw latches, making cleaning fast and effortless.

With interchangeable bodies—Sawed Off and Tall Boy—this taper easily adapts to both tight spaces and high ceilings, giving professionals greater flexibility on the job.

Handmade from carbon fiber, the Predator Taper is lightweight, durable, and fully modular. The removable head also allows for affordable repairs if needed—all without adding any extra cost compared to the original Predator Taper.

THREE BODY SIZES



Tall Boy 72"



Regular 48"



Sawed Off 36"



Removable Head

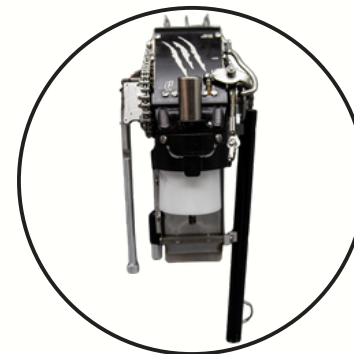

Item No.	Description
C1PTAPER	53" Columbia One Predator Taper
C1SPTAPER	39" Columbia One Sawed Off Predator Taper
C1TBPTAPER	77" Columbia One Tall Boy Predator Taper
C1PHEAD	Columbia One Taper Head
C1PBODY	48" Columbia One Predator Taper Body
C1SPBODY	36" Columbia One Sawed Off Predator Taper Body
C1TBPBODY	72" Columbia One Tall Boy Predator Taper Body

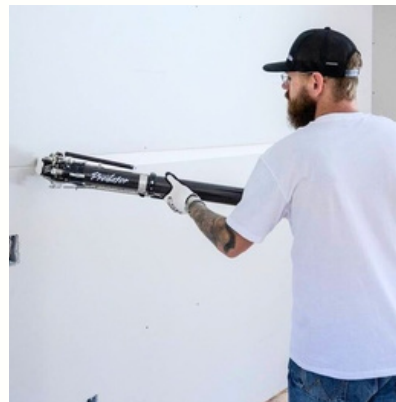

GET SOCIAL:
@columbiatools



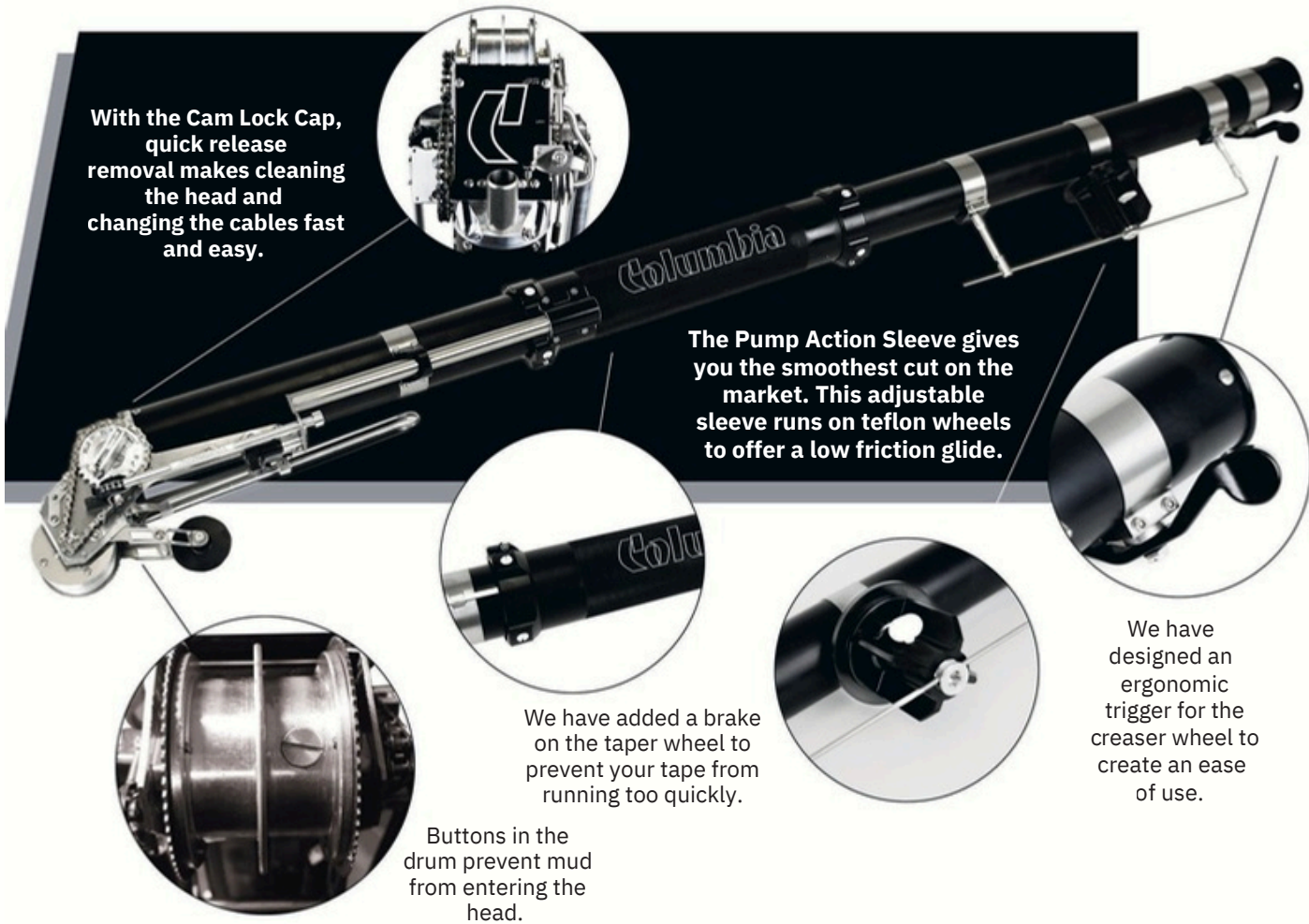

With the Cam Lock Cap, quick release removal makes cleaning the head and changing the cables fast and easy.

The Pump Action Sleeve gives you the smoothest cut on the market. This adjustable sleeve runs on teflon wheels to offer a low friction glide.

We have added a brake on the taper wheel to prevent your tape from running too quickly.

Buttons in the drum prevent mud from entering the head.

We have designed an ergonomic trigger for the creaser wheel to create an ease of use.

AUTOMATIC TAPER

We have been perfecting our Automatic Taper for over 40 years. The results of our superior engineering, craftsmanship and service are proven daily among the world's top commercial and residential drywall contractors. Our Taper has been specifically designed to run at peak performance in the most demanding commercial environments where daily punishment and abuse are run of the mill.

When you are tired of compromising, step into a Columbia Taper.

The Pump Action Cutting Sleeve on teflon slides gives the smoothest cut and the Cam Lock removable Cap provides as easy clean solution



GET SOCIAL:
@columbiatools

Item No.	Description
TAPER	Columbia Automatic Taper (53" length)
STAPER	Columbia Sawed Off Taper (39" length)

1.800.663.8121 / COLUMBIATOOLS.COM



CORNER ROLLER

Manufactured with a die-cast head and hardened stainless steel top rollers for long lasting angle work, no other roller can match it. These rollers are used after the Taper, on 90° internal angle joints on walls and ceilings to embed the tape into angles in preparation for the Angle Heads and Flushers. The Columbia Corner Roller features split hardened steel/Delrin wheels designed to reduce drag on tape and overall tool weight.

CORNER COBRA

The Corner Cobra is an amazing time saving tool. It allows the user to roll out No-Coat™ and other structural corner beads at almost all inside and outside angles. We have heard back from users that it does it quicker and better, which to us, is a home run. Another one of our patented products that is changing the time it takes to finish a job.



Works on inside and outside angles from 85 to 180 degrees.

Pivot head adjusts to angles.

Item No.	Description
----------	-------------

CC	Corner Cobra
CR	Corner Roller



COLUMBIA LAMINATE BEAD ROLLERS

Columbia Laminate Bead Rollers deliver fast and precise application of outside 90° laminate bead. Built with a billet aluminum body and premium materials, they ensure smooth, even pressure, durable performance, and a perfect finish every time. Available for order and shipping today.



Item No.	Description
CLBR	Columbia Laminate Bead Roller
CLBP	Columbia Laminate Bead Pro

OUTSIDE CORNER ROLLERS

Offering three different profiles, Columbia Outside Corner Rollers will be sure to make your tape on bead setting job faster. Whether you're applying standard, bullnose or euro bead, our rollers are designed to make the job easier and help you achieve a great finish every time.

Item No.	Description
COBCR	Standard Outside Corner Roller
CBNCR	Bullnose Outside Corner Roller
COBCRE	European Outside Corner Roller
COBCRW	Wide Outside Corner Roller

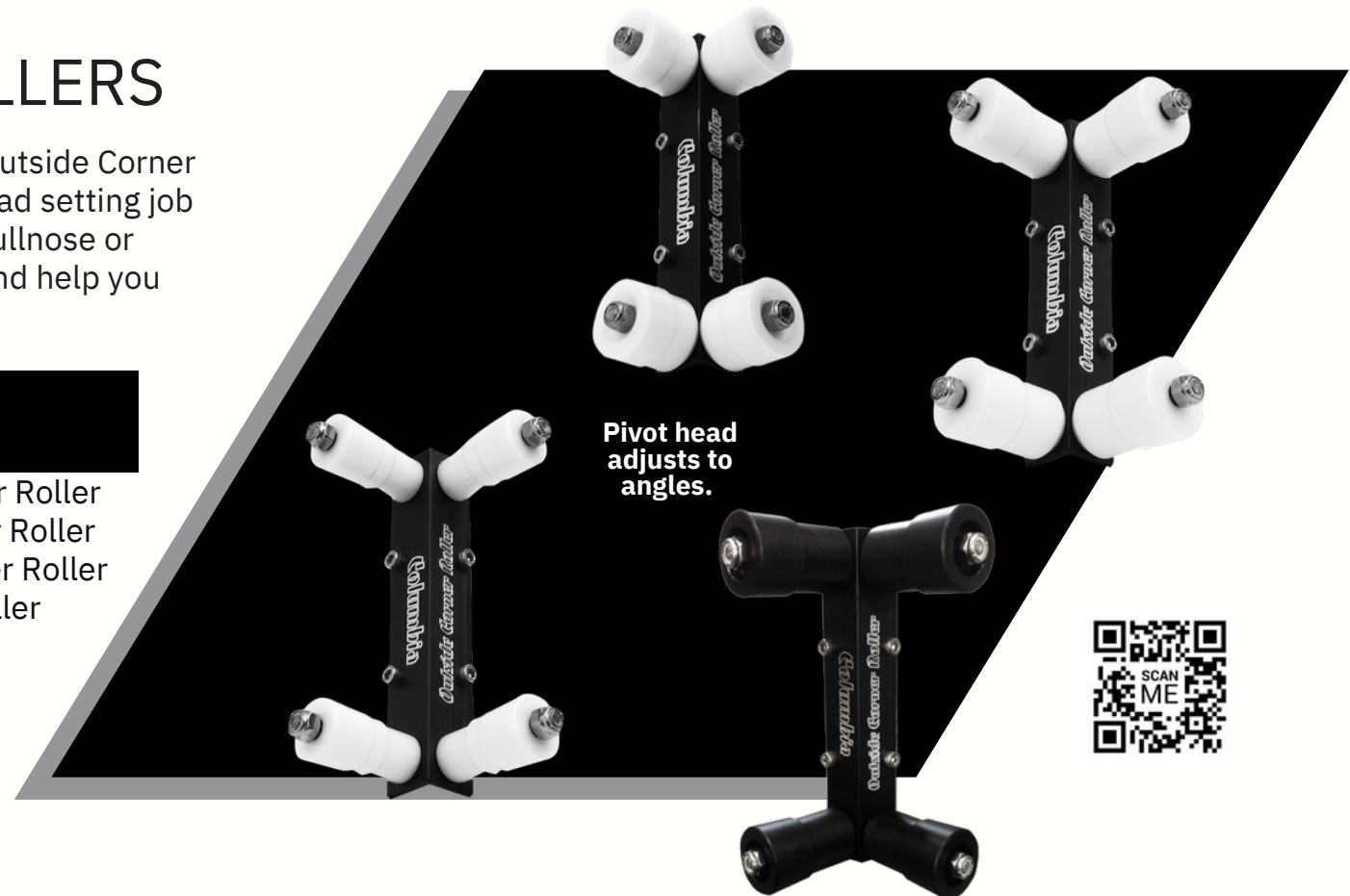

ANGLE HEADS

Columbia Angle Heads are the best money can buy! They professionally finish angles with the correct consistency of compound and the proper feathering of edges. Precision machined billet aluminum head and durable stainless steel wings ensure longer wear and performance. Angle Heads are used in 90° internal angle joints after the Corner Roller to evenly feather compound over tape. All Angle Heads come with wheels.

Item No.

Description

2AH	2" Angle Head 2.5"
2.5AH	Angle Head 3"
3AH	Angle Head 3.5"
3.5AH	Angle Head Angle
AHA	Head Adapter



THROTTLETUBE



Empty



Inside



Full

The white rod mud level indicator clearly displays the compound level. It extends outward as the tube is being filled and gradually retracts as the compound is used. When the red indicator becomes visible, it signals that the tube is fully filled.

The Columbia ThrottleTube delivers joint compound to corners with speed, precision and control. Built with a lightweight carbon fiber tube, it offers greater strength and durability than traditional plastic designs while staying balanced and easy to handle. A twist-activated piston provides smooth compound flow with instant shut-off.

With large compound capacity, the ThrottleTube reduces refills and improves workflow. Compatible with Columbia Angleheads and corner applicators for fast, clean corner finishing.

Item No.	Description
TT	ThrottleTube

THROTTLEBOX

The Throttle Box is another great product of ours that offers years of great performance. All billet construction with a threaded stainless steel ball, this Corner Box looks and operates seamlessly. All our Corner Boxes now come standard with automatic capabilities, making pushing the box at least 50% easier than standard boxes. The new springs have adjustable tensions and greatly reduce the occurrence of air pockets while running. The Throttle Box allows the corners to be quickly coated with your choice of angle head or applicator head. *Patent Pending

Billet handle mount will not crack under pressure like cast.



Solid stainless steel valve for lifetime usage. Will not leak like other welded thin wall designs.

50% easier to push!

Thumb release door stop for quick clean.

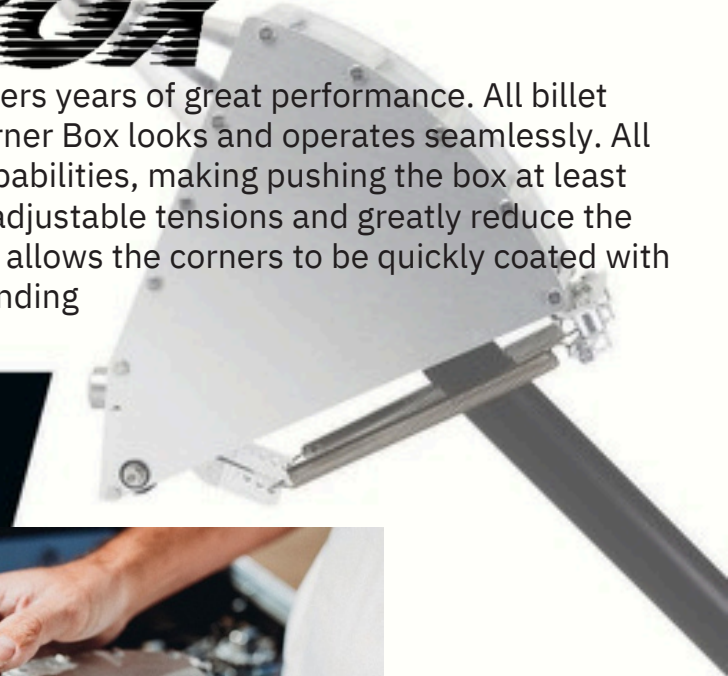

Item No.	Description
----------	-------------

7CFB

7" Corner Flusher Box

8CFB

8" Corner Flusher Box



NAIL SPOTTERS

Our Nail Spotter has an extremely light weight and durable design. It's hinged door allows for easy access and cleaning, and the adjustable thumb tension screw allows for quick and easy adjustment of pivot tension.

Item No.

Description

2NS	2" Nail Spotter
3NS	3" Nail Spotter
HNSA-5-2	2" Wheel Conversion Kit
HNSA-5-3	3" Wheel Conversion Kit



GET SOCIAL:
@columbiatools



FLAT FINISHER BOX

This is one tough tool. Our flat boxes are considered by many as the best on the market; they are designed to perform day in and day out to finish your job smoothly and evenly.

Item No.	Description
5.5FFB	5.5" Flat Finisher Box
7FFB	7" Flat Finisher Box
8FFB	8" Flat Finisher Box
10FFB	10" Flat Finisher Box
12FFB	12" Flat Finisher Box
14 FFB	14" Flat Finisher Box

The bead wheel axel will allow our users to run their Columbia Flat Boxes on the bead without wearing down the axel. Comes standard on all flat boxes.



Hinged door system allows you to remove springs eliminating back pressure and keeping the door against the mud at all times.

FAT BOY FLAT BOXES

Need a larger, stronger box with greater mud capacity for loading flats and butts? We are proud to meet your needs with our Fat Boy Boxes. Available in 8", 10" and 12" sizes, these boxes really go the extra mile. Fat Boys hold approximately 40% more compound than standard boxes, saving you many trips to the pump.

Item No.	Description
5.5FBB	5.5" Fat Boy Flat Box
8FBB	8" Fat Boy Flat Box
10FBB	10" Fat Boy Flat Box
12FBB	12" Fat Boy Flat Box



GET SOCIAL:
@columbiatools



INSIDE TRACK KIT

Use this kit to convert any box (with the exception of automatic boxes) from a regular axel box to an inside track box.

The main advantage of having wheels inside the side plate is in running butt joints and navigating obstacles such as potlights and door jams. The key is having the wheels inside the coating path of the box blade.

AUTOMATIC FLAT BOXES

The Automatic Flat Boxes reduce the need to push the compound on to the wall. By engaging, the box springs put pressure on the compound chamber requiring only a light push to operate the box. Well-built and fine-tuned to offer great flat joints for years.

Item No.	Description
8FFBA	8" Automatic Flat Box
10FFBA	10" Automatic Flat Box
12FFBA	12" Automatic Flat Box
14FFBA	14" Automatic Flat Box
8FBBA	8" Automatic Fat Boy Box
10FBBA	10" Automatic Fat Boy Box
12FBBA	12" Automatic Fat Boy Box
ITC-K	Inside Track Conversion Kit

FLAT BOX HANDLES

THE MATRIX

The Columbia Matrix Flat Box Handle is light-weight and all mechanical. With a 90 degree comfort grip, the Matrix gives you increased control over your box. These handles are durable and extremely long lasting, all while maintaining the comfort and ease of use that you're used to with the Columbia brand of tools.

The Columbia Matrix mechanical flat box handle is made of all billet aluminum, ensuring a long life.

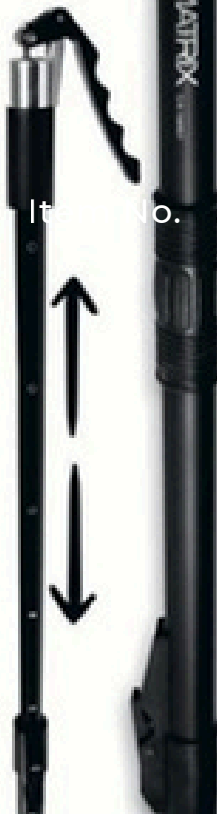

Item No.	Description
3BH	3' 180° Grip Flat Box Handle
42BH	42" 180° Grip Flat Box Handle
4BH	4' 180° Grip Flat Box Handle
5BH	5' 180° Grip Flat Box Handle
6BH	6' 180° Grip Flat Box Handle
CMH	Closet Monster Handle Matrix
MH	Flat Box Handle 40-60" Matrix
MHS	Flat Box Handle 29-39" Matrix
MHL	Flat Box Handle 56-76" Matrix

Closet Monster - perfect for small spaces.

180° Grip Flat Box Handles allow for continuous braking over the entire range of motion - a complete 180 degrees. This ensures that you never lose your grip when adjusting your position. Extra strong aluminum design for years of rugged use.



COLUMBIA ONE

The Columbia One Handle is designed to work with your Columbia products universally. From the Nail Spotters and Angle Heads, to the Rollers and the Throttle Boxes, the One system allows you to lighten your load and still utilize all the finishing tools you love.

The Columbia One Stubby is perfect for those smaller areas like crawl spaces and closets.

Item No.	Description
C1H	Columbia One Handle
C1HEXT	Columbia One Extendible (3-5')
CHXL	Columbia Long Extendible (4-8') (AH, CR, & NS only)
C1HS	Columbia One Handle Stubby
AHA	Anglehead Adapter



AHA
needed
for use
with AH.



MUD PUMPS

Our Mud Pumps are designed for easy priming and built for long-lasting performance with an anodized aluminum cylinder, stainless steel shaft, and precision-machined cast aluminum head.

Introducing the Predator Mud Pump: Made with advanced carbon fiber for a lighter, stronger, and smoother pumping experience.

The Tallboy Mud Pump lets you stand upright while filling tools and works with a 30-gallon pail, reducing mixing time and minimizing physical stress.

In collaboration with Graco, the Columbia X Graco PowerFill is a cordless, powered loading pump that eliminates manual pumping with just the push of a button.



Item No.	Description
HMP	Mud Pump
TBMP	Tall Boy Mud Pump
PHMP	Predator Hot Mud Pump
BF	Box Filler
TBBF	Tall Boy Box Filler
GN	Gooseneck
TBGN	Tall Boy Gooseneck
CPFP	COLUMBIA POWER FILL PUMP
CPFGN	COLUMBIA POWER FILL GOOSENECK

SEMI AUTOMATIC TAPER

The Semi-Automatic Taper or “Bucket Taper” allows users to apply a specific amount of compound to a large volume of tape. It has a tape spool with brake to cut down on operator fatigue. Columbia’s Semi Automatic Taper is easy to use, durable and has laser engraved instruction on the door.

COMPOUND TUBES

Built to last, and hands down the smoothest and most durable tubes on the market. Expect quality with our Compound Tube and our Cam Lock Tube. Available sizes include 24”, 32”, 42” and 55”.

Item No.	Description
SAT	Semi Automatic Taper
CMT24	24” Compound Tube
CMT32	32” Compound Tube
CMT42	42” Compound Tube
CMT55	55” Compound Tube
CLT24	24” Cam Lock Tube
CLT32	32” Cam Lock Tube
CLT42	42” Cam Lock Tube
CLT55	55” Cam Lock Tube



Tape spool with brake to control dispensing.

dispensing.

Stainless steel ball and billet aluminum head cone.



BILLET MUD APPLICATORS

These tools glide along the wall leaving the perfect amount of compound on flat surfaces. Machined from a solid piece of billet and then mounted with stainless runners, this tool is built to work.

UHMW MUD APPLICATORS

Our new plastic applicators are a hit! Proportionate grooves give you a consistent mud distribution on the wall and speeds up the pre-filling process. Made out of UHMW, the strong durable design makes these Mud Heads the best on the market.

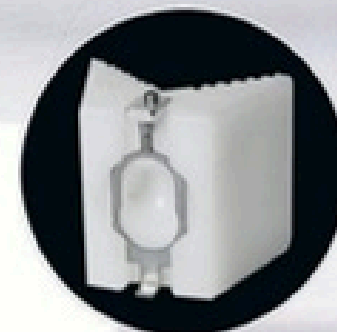

Item No.

Description

ICATW	Two-Way Internal Corner Applicator (4 Wheels)
ICA2-1	Inside Corner Applicator (2 Wheels) - 1"
ICA4-1	Inside Corner Applicator (4 Wheels) - 1"
CEXT90	External 90 Applicator
CFLT	Flat Applicator
FMH	L-Trim Applicator (Plastic)
IA90	Inside 90° Applicator (Plastic)
OA90	Outside 90° Applicator (Plastic)
OA90-325	Outside 90° 325 Applicator (Plastic)



1.800.663.8121 / COLUMBIATOOLS.COM

CORNER FLUSHERS

Columbia Corner Flushers are widely known for being the best on the market. These Flushers have redefined angle finishing. They are built from the best materials, but above all, every single Flusher is hand ground and quality checked on a granite plate for perfection. Flushers come with wheels for easy glide.



Item No.	Description
2.5SF	2.5" Standard Flusher
3SF	3" Standard Flusher
3WTSF	3" Widetrack Standard Flusher
3.5SF	3.5" Standard Flusher
4SF	4" Standard Flusher
2.5DF	2.5" Direct Flusher
3DF	3" Direct Flusher
3WTDF	3" Widetrack Direct Flusher
3.5DF	3.5" Direct Flusher
4DF	4" Direct Flusher
2.5CSF	2.5" Combo Flusher
3CSF	3" Combo Flusher
3WTCSF	3" Widetrack Combo Flusher
3.5CSF	3.5" Combo Flusher



THE PHANTOM DDM SANDER

The Columbia Phantom Sander is a dustless sander head, pole and hose that connects to any vacuum with a standard 1.5" inlet.

The pole extends 26" to 46" and the hose is 30 feet long. The Phantom sands corners easily because of its shape and collects 99% of dust.



THE SANDER HEAD

The Columbia Sander Head incorporates all of the industry's preferred functionalities in the first fully machined billet aluminum body. Utilizing our No Flip technology, our Sander Head flows smoothly on the wall.

Item No.	Description
PDDM	Phantom DDM Sander
CS	Columbia Sander Head
CSH	Columbia Sander Pole
TL-3-8	Twist Lock Handle w PHA



Uses the standard
paint handle thread.

1.800.663.8121 / COLUMBIATOOLS.COM

THE TOOL CASES

Columbia offers two storage cases for finishing tools. The Road Case measures 17"x9"x57" and is an extremely durable case built to endure the abuse of travel, and wear and tear of the jobsite. Ideal for the larger automatic tools, the Road Case features handles and wheels. The Columbia Gun Case is 53.4" x 16.5" x 4.5" and fits a complete set of semi-automatic tools. The plastic case features eggshell foam support to ensure the tools remain in place.

Item No.

Description

TCS
RC

Columbia Gun Case
Columbia Road Case



The Gun Case is lightweight, but strong, and can protect a full set of semi-automatic tools.

GET SOCIAL:
@columbiatools

MAINTENANCE KITS

Columbia offers many kits to keep your tools working for you. Available in a convenient clam shell case for easy storage of parts, each kit has an accompanying video on Youtube and on the Columbia website to walk you through every step of installation. And as always, our experts are only a phone call or email away!

Item No.	Description
AHR-BK-2	Anglehead Blade Kit 2"
AHR-BK-2.5	Anglehead Blade Kit 2.5"
AHR-BK-3	Anglehead Blade Kit 3.5"
AHR-K	Anglehead Maintenance Kit
CC-RK	Corner Cobra Maintenance Kit
CRA-2	Corner Roller Wheel Kit
CTA-41	Cutter Block Assembly
CTR-1	Taper Maintenance Kit
CTR-2	Taper Head Maintenance Kit
CTR-42A	Taper Blades Kit
CTR-63	Taper Needles Kit
CTR-72	Taper Cables Kit
FFBA-36	Box Wheels Kit
FFBR-7-7A	Box Shoes Kit
FFBR-9-5.5	Box Blades Kit 5.5"
FFBR-9-7	Box Blades Kit 7"
FFBR-9-8	Box Blades Kit 8"
FFBR-9-10	Box Blades Kit 10"
FFBR-9-12	Box Blades Kit 12"
FFBR-9-14	Box Blades Kit 14"
HNSA-5-2	Nail Spotter Wheel Kit 2"
HNSA-5-3	Nail Spotter Wheel Kit 3"
HNS7-2	Nail Spotter Blade 2"
HNS7-3	Nail Spotter Blade 3"
HHR-1	Hydra Handle Maintenance Kit
MPR-1	Mud Pump Maintenance Kit



SCAN THE QR CODE ON THE KIT WITH
YOUR CAMERA APP TO FIND
INSTRUCTIONAL YOUTUBE VIDEOS
FOR EVERY MAINTENANCE KIT!

1.800.663.8121 / COLUMBIATOOLS.COM

VIDEO LIBRARY

Supporting our customers is our number 1 priority! Columbia has created a detailed video library with playlists such as maintenance instructions for the kits (both live and animated) and explanatory candid series'. We also have created "How To" videos on nearly every tool to help the new and experienced user. New videos are released all the time. Our videos are not only on our new state of the art website, but they are also on our easy to locate Youtube channel. Users can find all the information they need... from tool use, to maintenance, to troubleshooting.

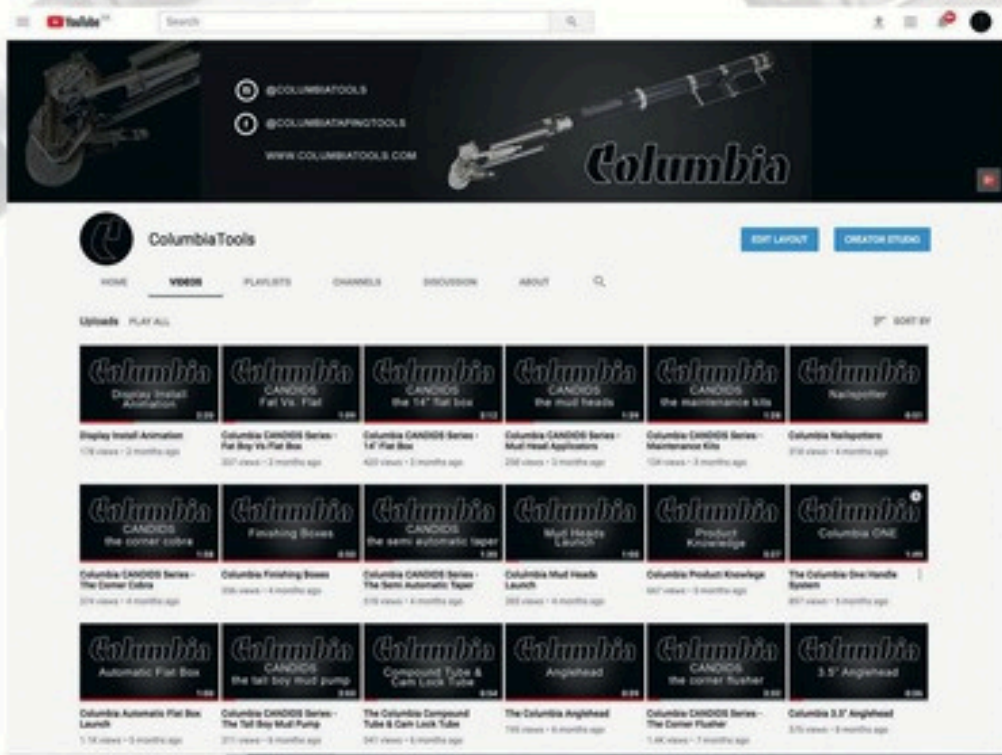

GET SOCIAL:
@columbiatools

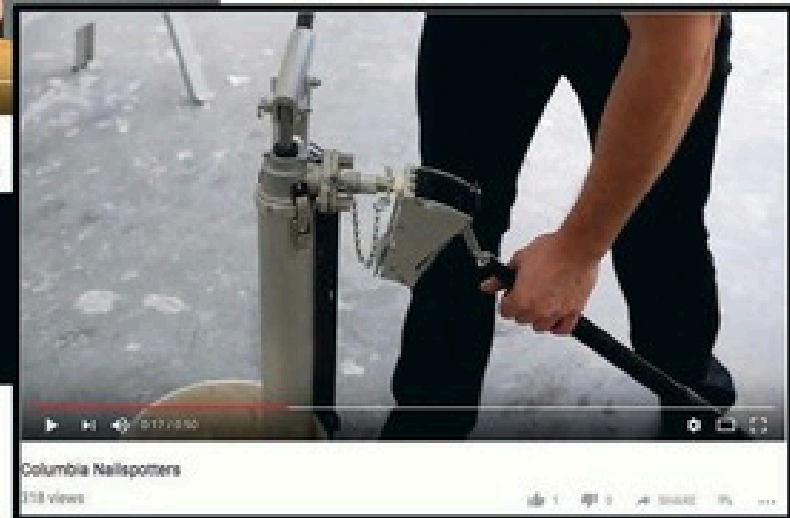
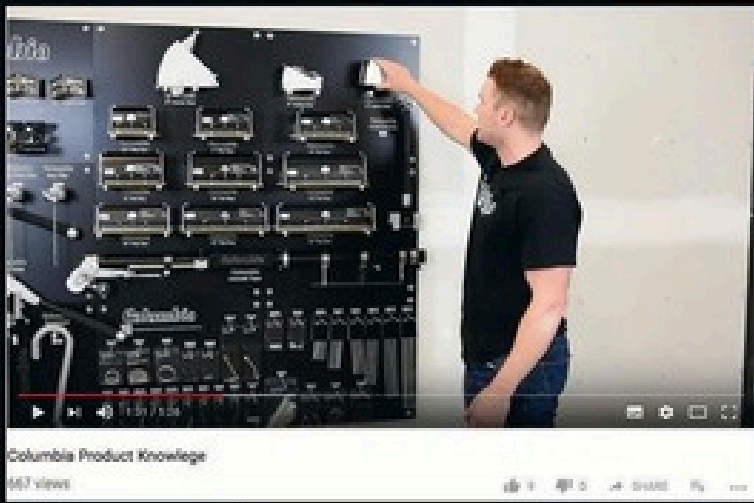
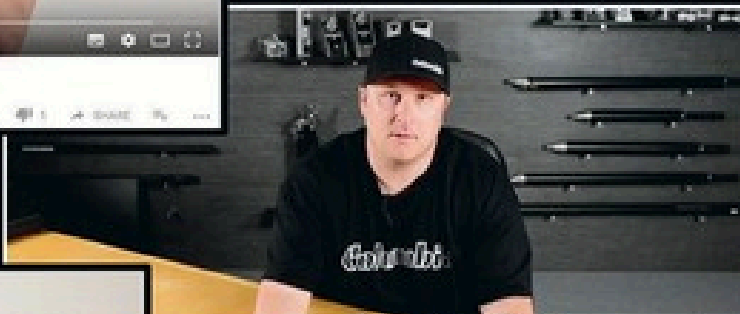
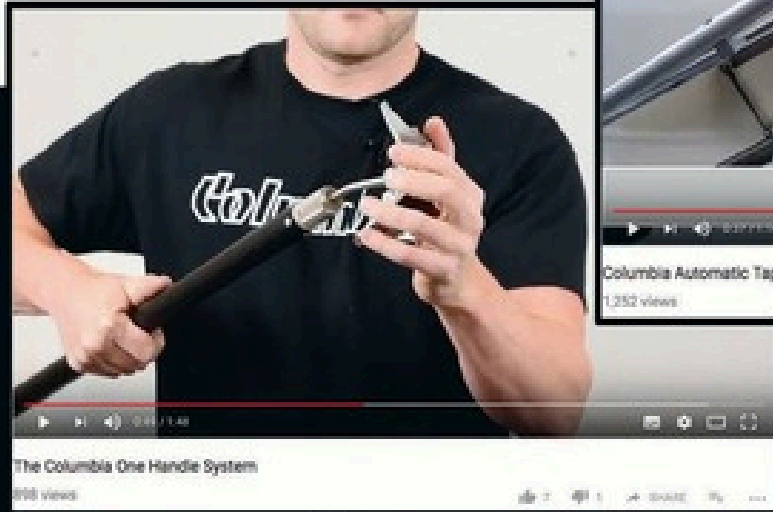

SOCIAL MEDIA

Join us on our social media channels! We post how-to videos with user based tips and tricks, keep you up to date on all the newest releases, and host giveaways and contests!



@columbiatools

@columbiatools

@columbiatools

FAMILY VALUES

STRENGTH. HEART. INTEGRITY.



When you buy from Columbia you are doing more than making a smart purchase. You are joining the Columbia customer family.

We are a family-oriented company with the kind of heart that distinguishes a champion from a challenger. Our values are as strong as our tools and our commitment to our customers is even greater.

We get our hands dirty every day and search for excellence in everything we do to give you the best experience possible.

GET SOCIAL:

@columbiatools

INNOVATION

Columbia prioritizes innovation for the industry. We strive to improve the experience for the end user.

The new tool releases, such as the carbon fiber Predator Automatic Taper, the Corner Cobra, the Tomahawk Smoothing Blades, the Phantom DDM Sander, the Matrix Box Handles, and the Road Case, combined with the existing tool upgrades, make Columbia the most innovative taping tools company on the market.

With upgrades to existing tools such as the Bead Wheel Axel addition to the Flat Boxes, the Cam Lock Taper Cap, and the Pump Action Cutting Sleeve, Columbia is always working to upgrade our tools to be at the forefront of industry trends.

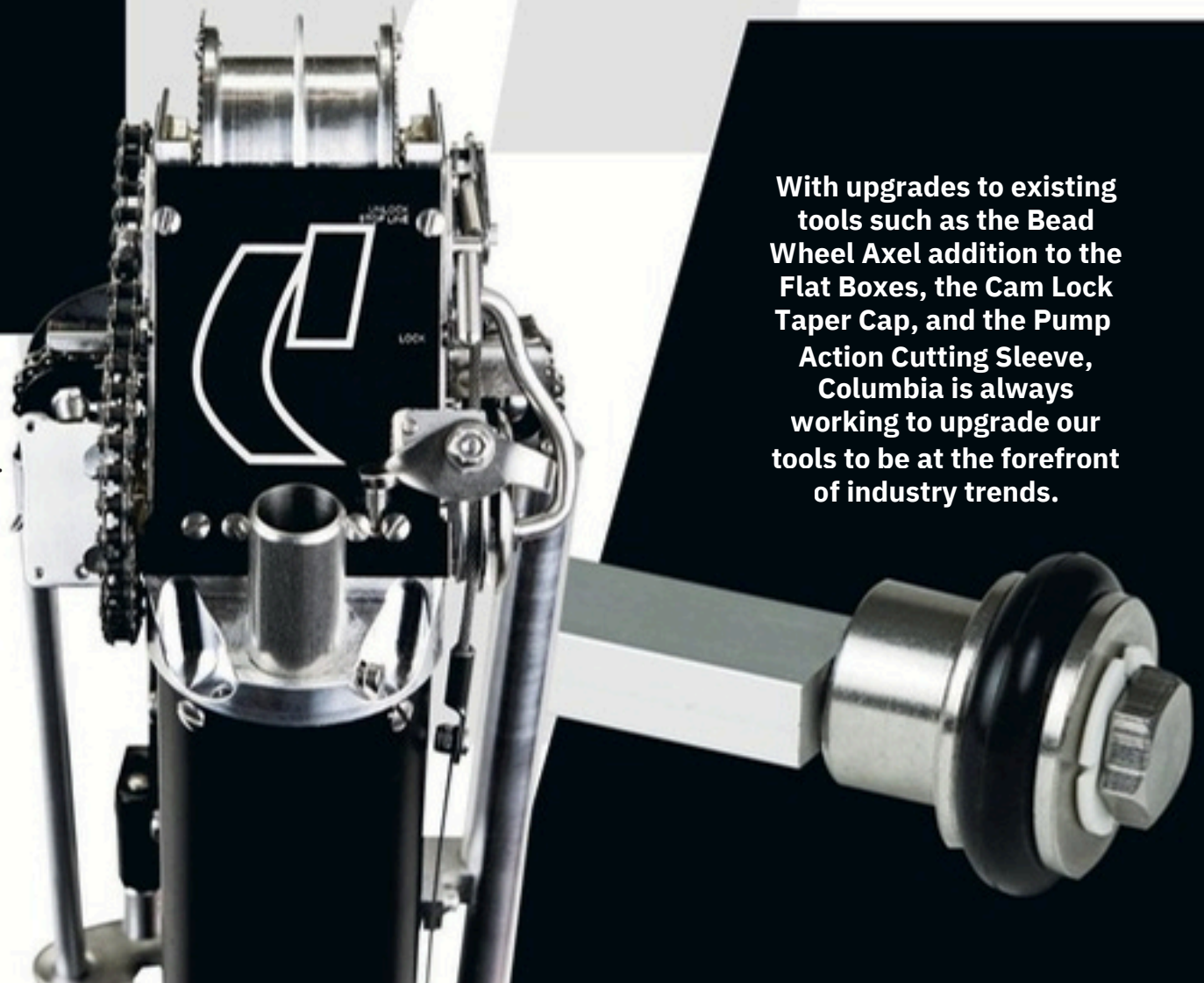

MAKING TAPING TOOLS EASY



QUALITY.
VALUE.
INNOVATION.

Columbia

support@columbiatools.com

1.800.663.8121

www.columbiatools.com

FB, YouTube, IG, TT: @columbiatools