

COLUMBIA TAPING TOOLS™

Tool Operation Manual

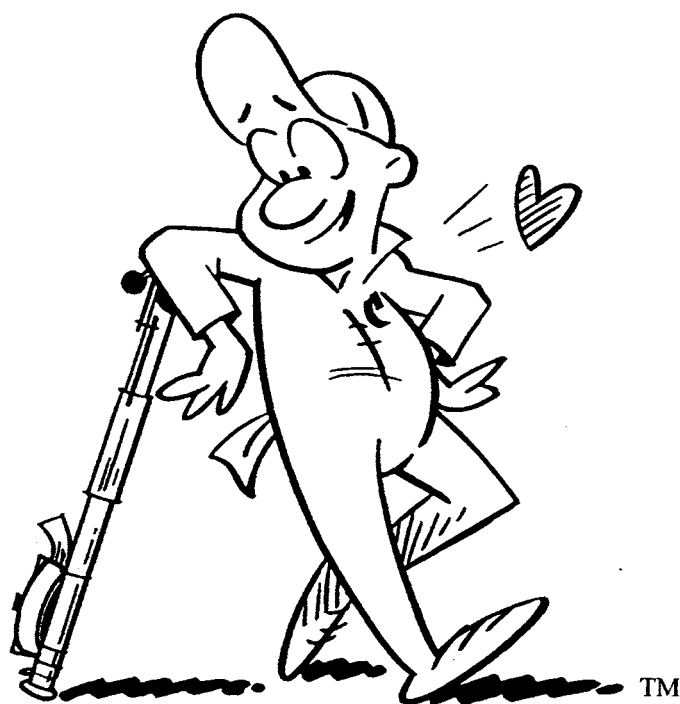

INTRODUCTION

DEAR CUSTOMER;

If you are reading this manual you are probably interested in learning how to use one or more of the products we manufacture. Or you might have seen the cartoon on the front and just wanted to check out what's inside. Either way I think you will enjoy watching Slick the Taper as he demonstrates what he believes to be the best method for using Columbia Tools. Slick is a hard working little guy who loves using his set of Columbia Tools on all his drywall jobs. Columbia Taping Tools is a family owned company that has been making tools since 1979. When we say making tools, we mean right from manufacturing the parts to assembly and representation in the field. We are a hard working group who's focus remains on having you the customer enjoy all aspects of our tool line. Whether it be the price, performance, durability or service we aim to offer you the best value in each category. We enjoyed making the manual and we hope you enjoy learning from it. If after reading through you still have a question give us a call at 1-800-663-8121.

Thank-you for using our tools!

The Columbia Staff

Table of Contents

Letter To Customers.....1
Columbia Taping Tools Products.....3

PART 1

Basic Taping Outline.....5

PART 2

The Columbia Automatic Taper.....6

PART 3

The Columbia Flat Boxes.....40

PART 4

The Columbia Nailspotter.....47

PART 5

The Columbia Angle Tools.....49

PART 6

Repair and Parts Information.....56

Columbia Taping Tools Products

Columbia Taping Tools is proud to offer a complete line of automatic drywall tools. With the drywaller in mind, our tools are crafted with great care. Our products are sold through a network of dealers and distributors internationally.

List and Description of Products

- **Automatic Taper**
Simultaneously applies tape and joint compound to horizontal wall joints, ceiling and butt joints, and internal angle joints.
- **Corner Roller w/Handle**
Embeds paper tape into 90° internal angle joints on walls and ceilings.
- **Angle Heads 2", 2 ½" & 3"**
Feathers joint compound evenly to wallboard in all 90° internal angle joints after using corner roller.
- **Angle Head Handle**
- **Corner Flusher Box w/Handle**
Used along with angle head it applies a finishing coat to all 90° internal angle joints.
- **Flat Box 7", 8", 10", 12"**
Distributes joint compound in correct amounts on horizontal joints. "Crowns the joint."
- **Flat Box Handles**
Used with Flat Boxes, various lengths to suit – 3', 42", 4', 5', 6'
- **Nail Spotter w/Handle**
Applies joint compound to nail and screw depressions.
- **Mud Pump**
Loads all Columbia tools with joint compound
- **Hot Mud Pump**
Loads fast setting joint compound into Flat Boxes, Corner Flusher Boxes, and Nail Spotters. May also be used as filler pump when using regular joint compound.
- **Gooseneck**
Pump attachment for filling Automatic Taper.
- **Standard Fitting**
Pump attachment for filling Flat Boxes and Nail Spotters

GETTING TO KNOW YOUR COLUMBIA TOOLS

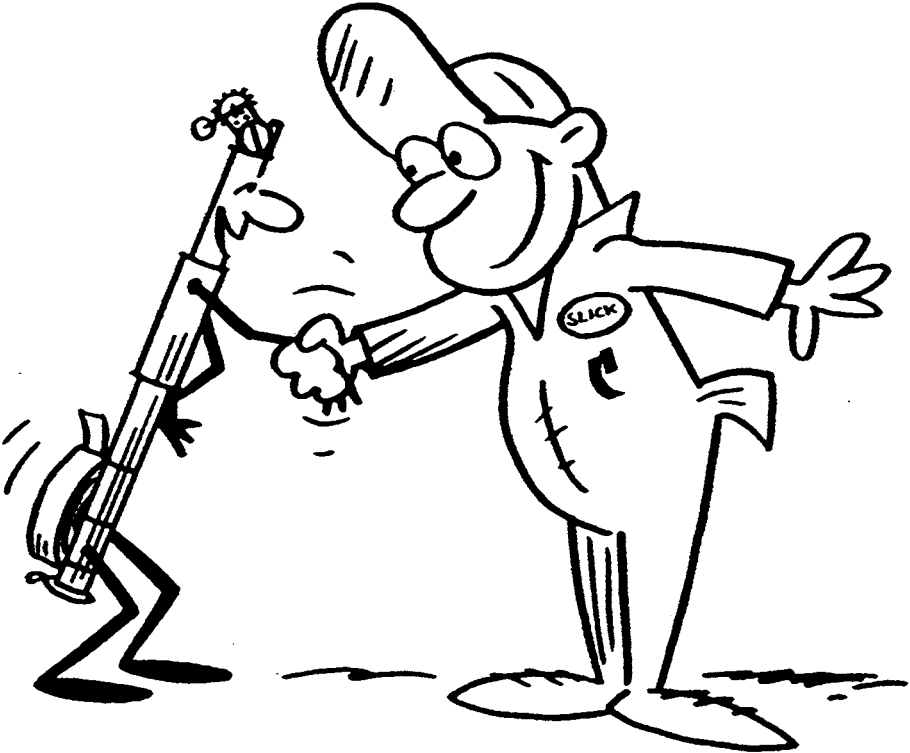

Part 1 Basic Taping Outline

Step 1

Processes

- a. Tape all horizontal joints and all 90° internal angles
- b. Wipe down all horizontal joints
- c. Embed all internal angles
- d. Wipe clean and feather all edges of 90° internal angles
- e. Clean up all 3-way angles by feathering excess taping compound

Tools Required

- a. Automatic Taper
- b. Broad Knife
- c. Corner Roller with Handle
- d. 3" Angle Head with Handle
- e. Broad Knife

Step 2

Processes

- a. Apply first coat of joint compound to all nail or screw depressions
- b. Apply first coat of joint compound to all horizontal joints

Tools Required

- a. 2" Nail Spotter with handle
- b. 7", 8" or 10" Flat Box with Handle

Step 3

Processes

- a. Apply second coat of joint compound to all nail or screw depressions
- b. Apply second coat of joint compound to all horizontal joints

Tools Required

- a. 2" or 3" Nail Spotter with handle
- b. 10" or 12" Flat Box

Step 4

Processes

- a. Apply second and final coat to all internal angles
- b. Apply finish coat to all nail or screw depressions
- c. Apply final coat to all horizontal joints

Tools Required

- a. Corner Flusher Box with handle and 2" or 3" Angle Head
- b. 3" Nail Spotter with handle
- c. 12" Flat Box with handle

Step 5

Sand and/or prepare drywall for finish coat; i.e., smooth wall, slick finish, splatter, orange peel, skip trowel, acoustic, or knock down textures, etc.

Part 1 THE COLUMBIA AUTOMATIC TAPER

Introduction

Taping with the Automatic Taper is the most common method of taping in the drywall industry. This tool lets the drywall finisher do automatic, high volume work. It is a highly productive machine when in the hands of a skilled operator; for example, it is possible for a good operator to put on two or more boxes of tape (upwards of 5 miles of tape) in an 8 hour day. It takes a small amount of time for one to become a skilled user of this machine but this time spent is repaid in greater productivity.

The Columbia Automatic Taper is designed to be the lightest, fastest, smoothest-running taper available. This machine operates on basic principles, drive wheels turn as the machine runs along the wall and in-turn they operate a plunger mechanism which coats the tape with joint compound. The automatic taper therefore simultaneously applies paper tape and dispenses the correct amount of joint compound to joints on walls, corners, and ceilings.

Automatic Taper Components

The Automatic Taper includes the following components, as illustrated in the figures:

- A barrel (CT# 103) for holding a supply of mud
- A handgrip (CT#126) for ejecting tape and cutting tape as the Taper moves over the joint.
- A cutter block (CTA41) assembly for cutting tape.
- A crimping wheel (CT#47) to crimp the tape on the inside angles.

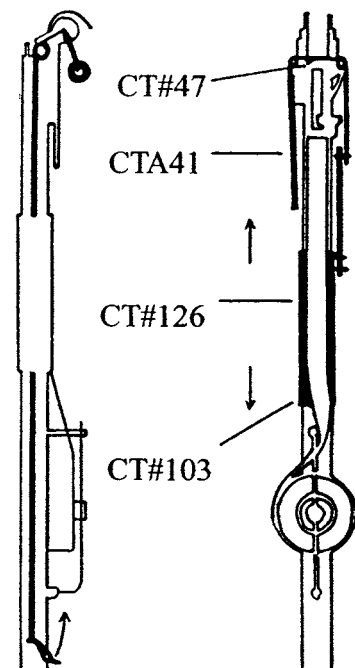

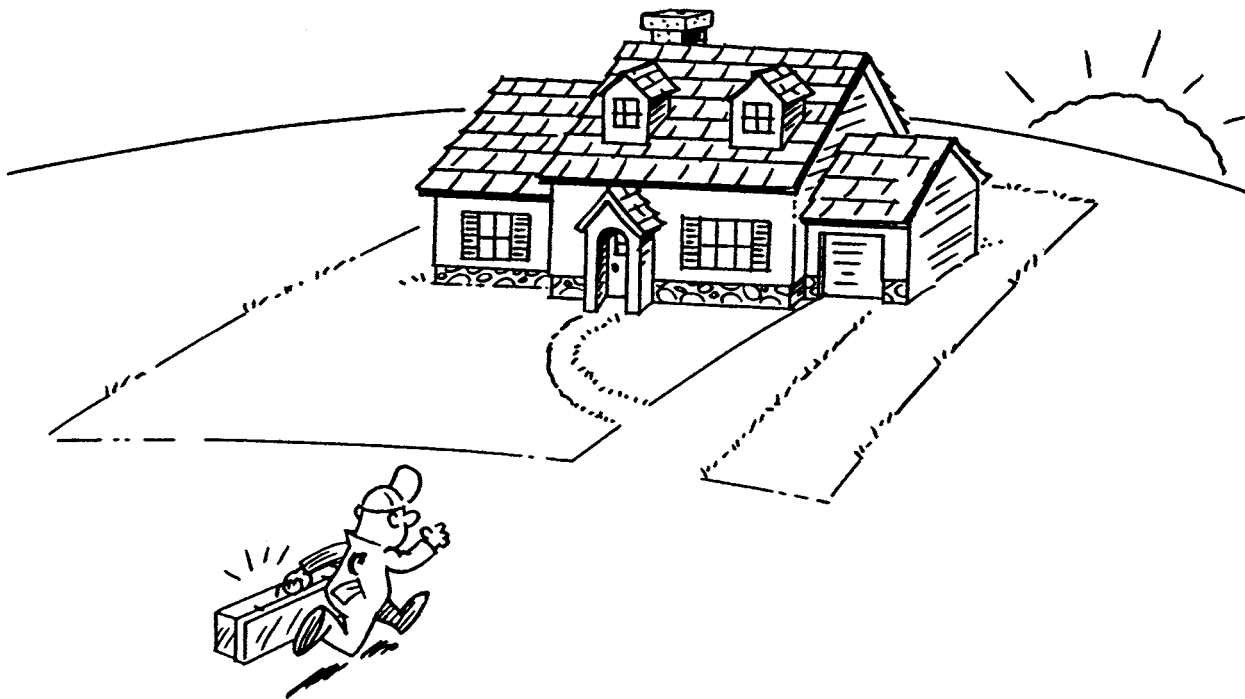

Getting Started...

WHAT YOU NEED TO GET STARTED

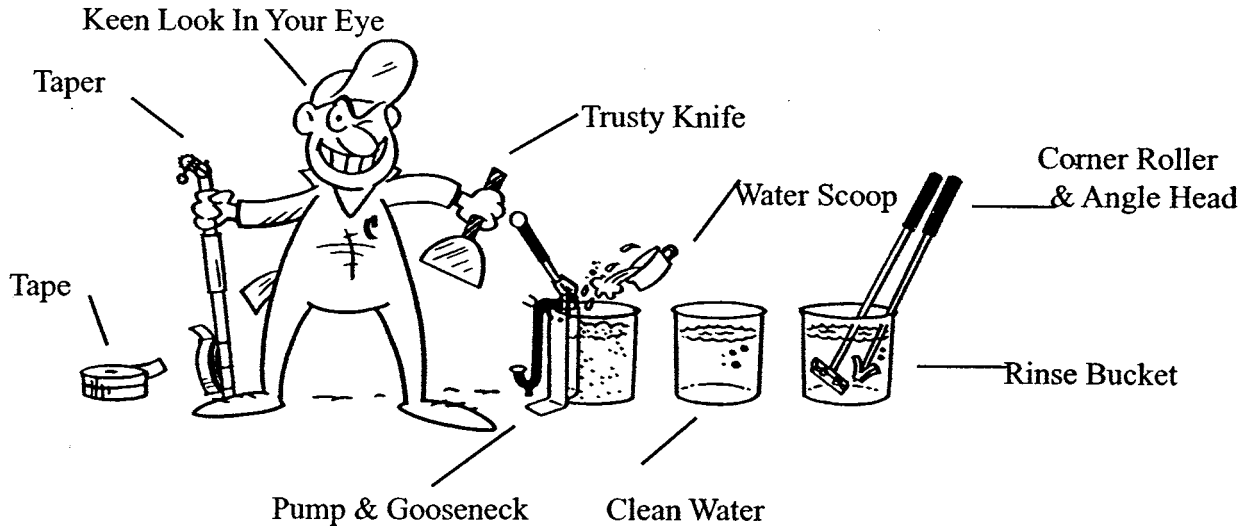

Either single operator or an operator and wiper crew (hereafter called a wiper) can operate the taper. It is most efficient with a three-man crew: one to operate and two to wipe. The automatic taper method of taping is applicable to various types of taping jobs ranging from single units (houses) to multiple units (high-rises and condominiums). Besides high output, other advantages of the taper include the following: In up to 8' 6" rooms all taping can be done from the floor, and it is relatively clean because the only contact with joint compound occurs when applying short tapes. With the use of proper technique the time spent training is repaid in the form of higher productivity. Care must be taken when operating an Automatic Taper. These machines when loaded can weigh close to 50 lbs., and handling it incorrectly can cause strain, which can eventually lead to injury. Therefore it is suggested that correct body techniques be used when operating a taper. The proper techniques are demonstrated throughout this manual.

Preparing to Tape With Your Columbia Taper

Tools Required

- At least three pails are needed with a taper – one for mixing joint compound, one filled with water for rinsing the taper head, and one for holding water for mixing.
- Additional pails are useful as they permit the mixing of several pails of joint compound at a time.
- A Columbia mud pump complete with gooseneck is required to fill the Automatic Taper.
- The machine operator should carry a knife to cut paper and plastic out of joints. For angles a Columbia roller and angle head are needed. If wipers are included in the crew they should have the knife and operate the angle heads and rollers.

Loading Rolls of Tape

Before loading tape, make the following checks:

1. Pull down the hand - grip CT# 126 to make sure the cutting blade moves smoothly.
2. Check the drive wheels CT#67 to make sure they move freely.
3. Push the crimping lever CT# 105 and release it to make sure the crimping wheel moves freely and that it returns to the normal position.

Follow these procedures to load a roll of tape:

Remove the CT #119(retainpring) and place the tape on the spindle so that the tape rolls from the bottom of the roll to the head of the machine or in other words unwinding clockwise as you look at the roll . The reason for this is that when the tape is twisted to go into the head, the twist will be the right way so that it doesn't interfere with the CT #126 (Hand Grip Body).

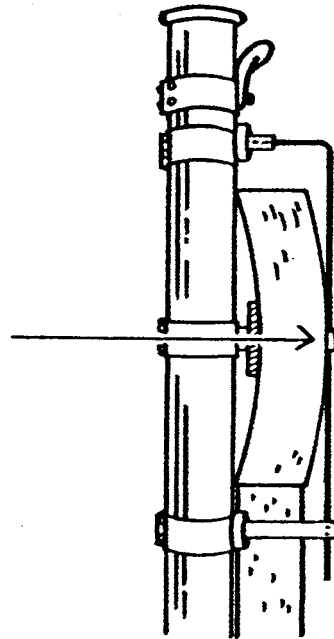
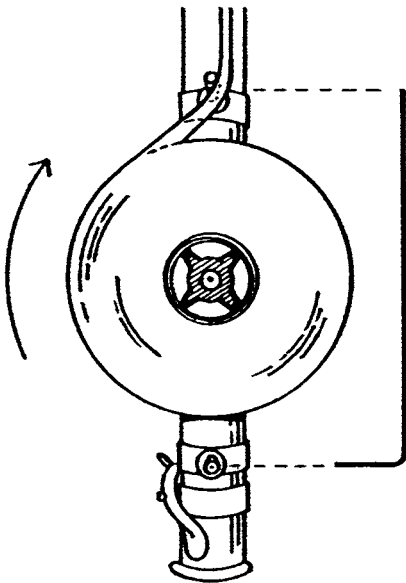

Replace the wire and make sure the tape rolls freely. It must not however, roll too freely, i.e., the tape should not continue to unroll after the machine stops. When this occurs push the center of the tape so that the edge of the roll rubs slightly on the CT #119 retaining spring. This will slow it down.

Having put the roll in place, set the end of the taper on the floor so that the toe of your shoe catches the crimper lever (to extend the lever and get it out of your way) and one hand should support the machine on the hand-grip. The CT # 126 (Hand grip) should be in the neutral position.

With your free hand, pull the tape toward the head of the machine, giving it a quarter turn so that the buffed side of the tape is toward the machine. Slide it into the CT# 19 Paper Feed Guide at the base of the head. Make sure that the tape runs over the top of the hand on the collar, and that the edges of the tape do not touch your skin. Paper tape can cause painful cuts!

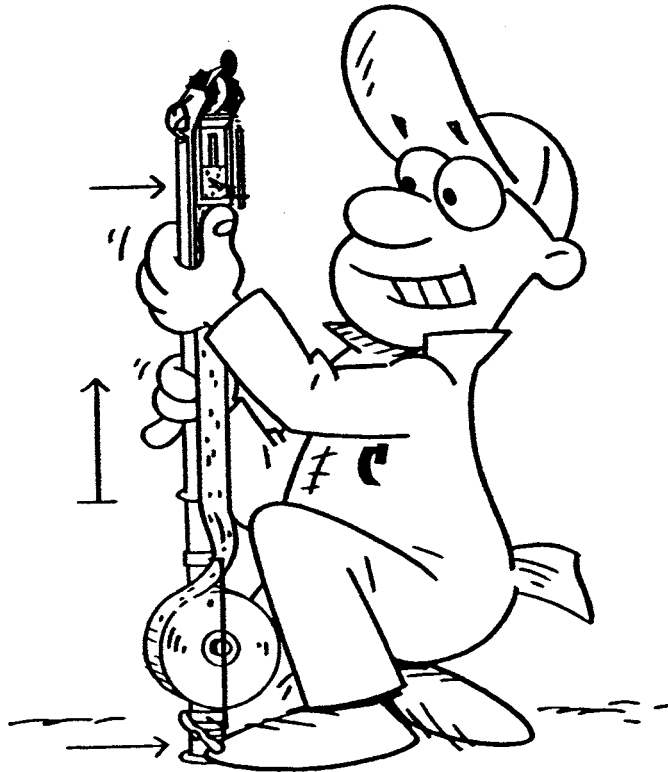

Check that the paper feed guide CT# 19 is free of joint compound and that the tape moves freely through it. Push the tape up the channel until it is approximately ½” past the needle. Lift up the hand – grip to raise the needle, and feed the tape through and out of the head of the machine. The natural curl of the tape should come out over the drive wheels .

When the tape appears over the drive wheels, pull down on the CT#126 hand–grip to cut the tape and check that the blade is making a clean cut. Rough, torn edges or jamming of the blade indicates that the blade is broken or dull and should be replaced. Several pieces of tape should be cut to make sure the blade is sharp and freely returns to the neutral position. Note: Wet tape will not cut and will jam the blade, so pull enough tape through until the blade cuts dry tape.

Loading your Columbia Taper with Joint Compound



CEILINGS



ANGLES

THE DRIP TEST

Consistency of Mud

Joint compound should be mixed fairly thin and smooth so that it can be poured from one pail to another. Joint compound for horizontal flat joints is usually thicker than joint compound for the angles. If the joint compound is too thin for the flat joints, the tape will slide along the joint and leave one end too short. Thin joint compound on the flats can also cause the upper edge of the tape to peel off the wall when it is applied because the compound will not be thick enough to hold it in place. The compound is mixed thinner for angles so that the tape can be more easily creased to form a square corner. If the joint compound is too thin, it will run down the wall when the angle is flushed.

Loading The Columbia Taper With The Mud Pump

Place the round tube of the pump in a pail of joint compound. The side of the pail should slide between the round tube and the pump leg. The pump leg is equipped with a footpad. Step on the footpad with one foot. This ensures that the pump will not wobble when the taper is being filled.

Use the pump without a screen when filling the taper. The reasoning behind this is that if the pump screen plugs the pump needs to be pulled out of the pail and the screen will need cleaning. This is a messy and time consuming procedure, which leads to, reduced productivity. Instead mix the joint compound so that there are few if any lumps. Even if a few lumps pass into the taper (since there is no screen), they shouldn't cause any problems.

In order to prevent air bubbles from getting into the Taper, the pump should not be removed from the pail. Air bubbles are a major problem in that if seen they slow the wiper's work, and if not seen they can create defects in the finished work.

Pump the handle approximately 4 or 5 times until joint compound is visible at the end of the gooseneck. This prevents air from being pumped into the Taper. If the pump is new or was thoroughly washed out after its last use, you may have trouble getting it to pump. In this case, short, fast strokes on the handle should get it going; if not, remove the pump from the joint compound pail and place it in a pail of water, again giving the handle short fast strokes. If it still doesn't work, turn it upside down and pour water into it or pour the water into the exit port and pump the handle. This should get the plunger wet and create the necessary suction to pump joint compound. If all these procedures fail, a part is most likely worn out and the pump will need to be returned to your local Columbia dealer or distributor for servicing.

Filling Procedure

1. On the right side of your Columbia Taper head is a small hook shaped lever (CT #93 Mud shut off lever arm), which operates the mud gate, this in turn lets the joint compound out onto the tape. During taping gate lever must be up and the gate open; during filling however, this lever must be down and the gate closed. The gate lever strikes against a rounded disc (CT# 85) when it is pushed down. This disc must be pushed in before the lever can be set in its down position. The disc is connected to a shaft; the shaft engages and disengages a drive mechanism that turns the drum, winds the cable, and pulls up the plunger when the Taper is operated.

Prior to filling the Taper:

- a. Push the CT #93 lever down until it strikes the steel disc of the CT #85 clutch release shaft .
- b. As the lever strikes the pulley, push the pulley in with the thumb of your other hand and continue pushing the lever until it reaches the down position. Note: The lever must be completely down so that the gate is tightly closed thus allowing no joint compound to flow out of the head of the machine. Also note that the pulley must be pushed in to disengage the drive mechanism allowing the drum, cable, and plunger, to roll freely as the Taper tube fills.

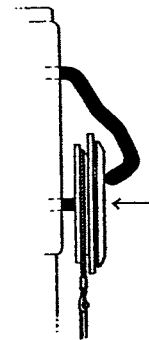

2. Locate the CT #97 filling nozzle on the flat plate on the Taper head. This nozzle contains a spring loaded valve that allows joint compound to flow in but not out.

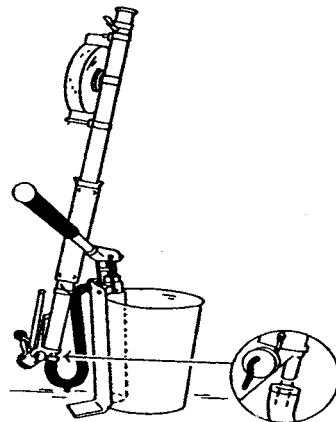

3. Insert the nozzle into the opening at the end of the gooseneck of the pump.
4. Lay the Taper into the cradle of the gooseneck (Fig. 9). It should stand on its own with its wheels facing away from the pail.
5. Place your foot on the footpad of the pump leg and with your left hand at the open end of the Taper to feel the plunger when it reaches the top.

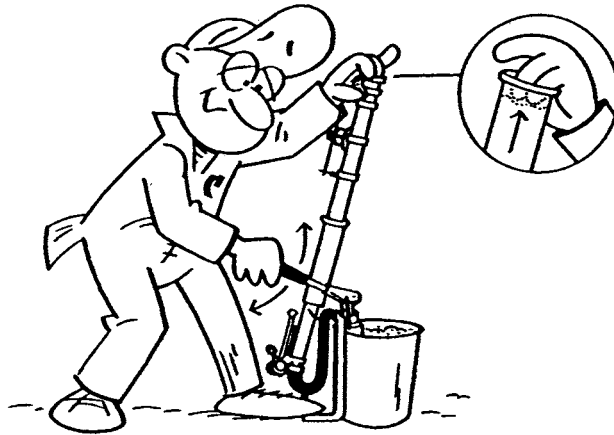

6. Pump the joint compound into the Taper. It should take 8 to 9 pumps of the handle to fill. Note: Remember this because any more means that there is a leak somewhere and air is getting into the Taper.
7. As you feel the plunger reaching the top stop pumping: too much pressure will force the plunger to the end, creating pressure build-up, causing joint compound to shoot out the head.
8. Remove the machine from the cradle and hold the head so it points into the pail.
9. Lift up the lever CT#93 that operates the mud gate to the taping position. This will cause a bit of joint compound to squirt out of the head from the pressure in the tube. Wipe the excess compound from the tape on the edge of the pail.
10. The Taper is now ready for taping.

Troubleshooting when filling the Taper

- Problem:** Joint compound runs out of valve as you pick the Taper up.

Cause: Something has jammed the valve open.

Effect: If left jammed while tape is run onto the wall, the joint compound will run out of the valve and reduce the amount going onto the tape, as well as make a mess.

Solution: By pushing inside the valve with a nail or rigid piece of wire, you can usually free the valve. Note: Do not use plastic coated electrical wire since a piece of the coating could be cut off and get stuck in the valve seal itself. If after this the valve still remains stuck it may have to be removed for cleaning.

Remove valve by first loosening the CT #145 screw that locks the valve in place in the head and then by tapping a screwdriver against the screw on the valve. If this doesn't budge the valve you can use a pair of pliers but make sure to place the pliers at the bottom of the valve. Twist the valve with the pliers to pull it out. Be careful not to bend or otherwise disfigure the valve. Wash the valve in water and remove the material jamming it. Check that the spring has enough tension to form a tight seal. In replacing the valve make sure it sits evenly in the hole. You may have to tap it a bit to press it back into the hole but do not tap the end of the valve with a hard material. Instead use a piece of wood or similar soft material to avoid damage that would prevent the nozzle from fitting tightly into a gooseneck. (When replacing valve use silicone to seal it).

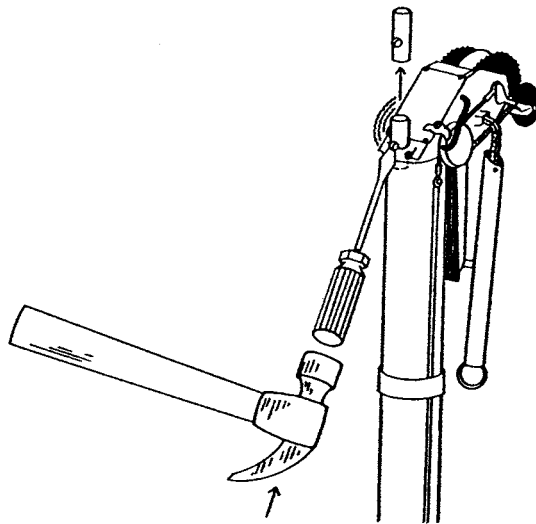

- Problem:** Joint compound will not pass through the valve into Taper although the valve appears clean.

Cause: Dried joint compound trapped in the spring preventing the valve from opening completely may cause this.

Solution: Remove the valve and tap the spring to dislodge the dry joint compound, then work the spring until the valve freely opens and closes. Washing the valve thoroughly after use will prevent this problem.

- 3. Problem:** Another problem that can occur when filling older machines is that the CT #43 cutter blade chain becomes slack and can jam the CT# 80 (Manual drive grip). If the pump applies pressure the cable may break. Check for chain slackening and if necessary have chain replaced.

Priming a Newly Filled Taper

Each time a Taper is newly filled:

1. Give the CT #80 (drive grip) on the left side of the head a turn or two to bring the CT#107 plunger up tight against the joint compound in the tube and feed compound onto tape.

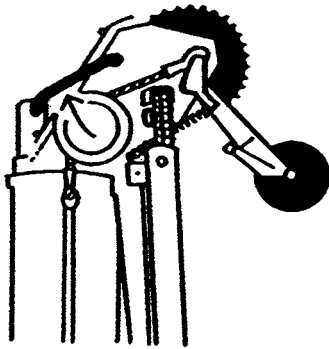

1. Run a horizontal flat wall joint (less than 1 yard) that does not interfere with butt joints or if there isn't such a flat joint in the room run an upper wall butt joint or a vertical flat joint. This procedure eliminates dry spots or air pockets under tape by ensuring that the plunger is brought up tight against the joint compound and does not slide back as it would in the upright position if you did a ceiling flat first.

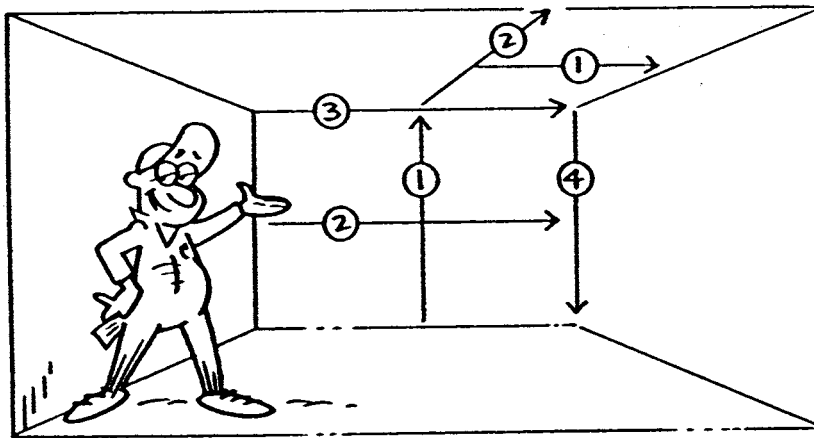

WHAT'S A JOINT LIKE YOU DOING IN A ROOM LIKE THIS?

Taping Sequence

The general sequence for machine taping a room is usually: butt joints on the ceiling, butt joints on the walls, horizontal joints on the ceiling, horizontal joints on the walls, short tapes, and angles. The reasons for this sequence are as follows:

1. The wiper will not have to wipe intersecting butt and horizontal tapes where both tapes are unwiped.
2. The taper and wiper will stay out of each other's way.

A recommended sequence for applying angle tapes with a machine is as follows:

1. Start at the first vertical angle closest to the door as you walk in the room.
2. Tape the vertical angle.
3. Tape the horizontal angle to the right.
4. And so on, the vertical angle, then the horizontal angle to the right until you return to the vertical angle you started at. Note: Taping to the right is recommended because most taping machines are designed to work best to the right.

Taping with your Automatic Taper

Horizontal Joints

BASIC PROCEDURES FOR TAPING HORIZONTAL FLAT JOINTS

Put both Taper wheels on the wallboard at the beginning of the joint. Roll the wheels forward simultaneously pushing the CT#126 (hand grip) advancing the tape. Thus the tape and joint compound will feed together. Pre-run approximately 3 inches and then run the rest of flat horizontal joint. When the CT#97 (joint compound valve) bisects the angle (approx. 3" before the end of the flat horizontal joint), cut the tape. Finish with hand-knife—start at center of horizontal wall joint and move toward end—do the same in the opposite direction.

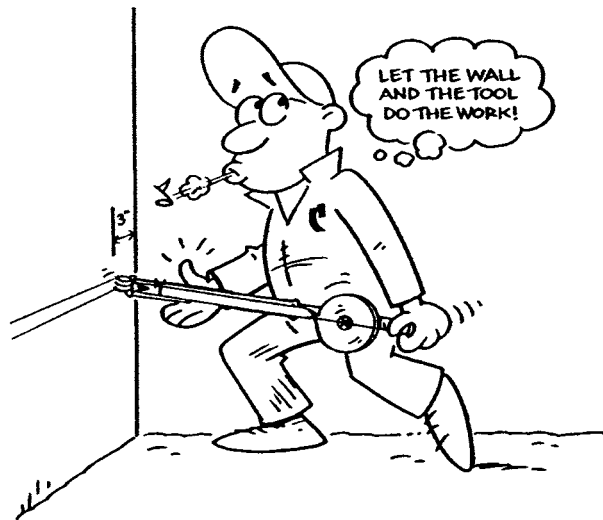

Procedure for holding Taper while taping Horizontal joints

To run a horizontal joint, turn your body so that you can walk forward. Push the taper with it contacting the joint about 10" in front of your body at the angle between 45 and 60 degrees to the wall. Check your path for obstacles. To apply pressure, pull the bottom end of the machine away from the wall with your left hand while your right hand acts as a fulcrum. By locking your right arm in close to your right hip, it should support the weight of the machine. In addition to applying pressure, your left hand also regulates the angle of the machine to the wall.

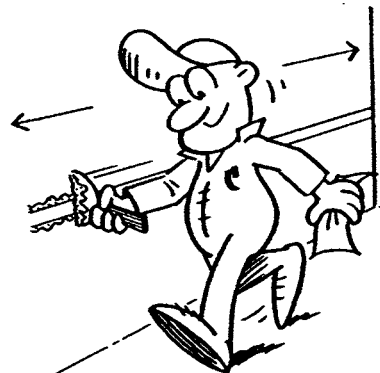

Cieling Joints

PROCEDURE FOR TAPING CEILING JOINTS

Put both wheels of the Taper on the wallboard at the beginning of the joint. Roll the wheels forward simultaneously pushing the CT# 126(hand-grip) advancing the tape. Thus the tape and joint compound will feed together. For flat horizontal joints, pre-run approximately 3 inches and then run the rest of the horizontal joint.

After 5 inches, partially rotate machine so that only one wheel touches the ceiling. This will leave joint compound under the full width of tape. If both wheels are placed on the wallboard, joint compound will be squeezed from under tape and drip to the floor.

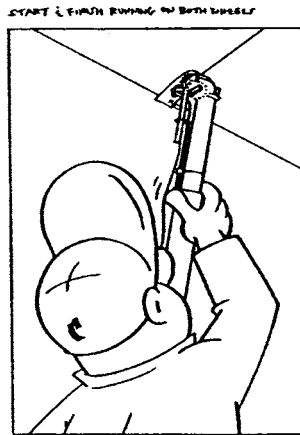

Procedure for holding Taper while taping Ceiling Joints.

The taper should contact the ceiling about 10 in. ahead of your body as with horizontal wall joints. Your right arm acts as a guide while your left arm applies pressure. To minimize strain on your body joints, distribute the weight over your body by keeping your right arm as straight as possible by locking it into a comfortable position. The head of the machine should be to the right of your right shoulder for two reasons: loose joint compound will not fall on you, and in this position you create an angle between yourself and the joint that permits one wheel of the machine to lift off the board.

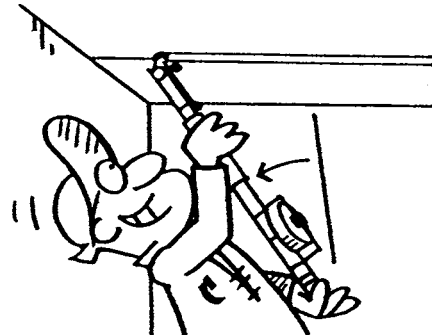
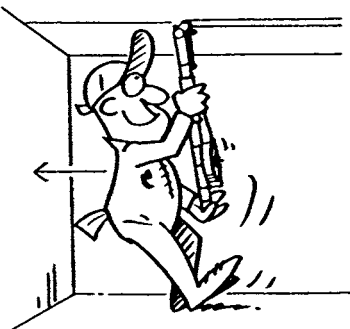

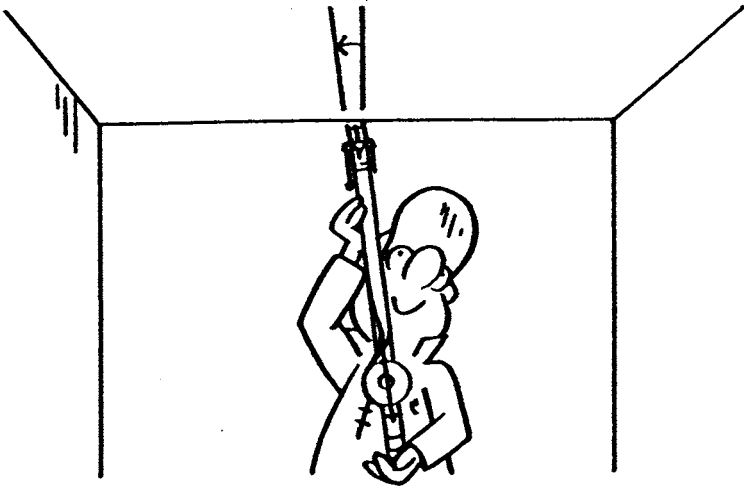

RIGHT

THERE ARE TWO WAYS TO DO THINGS

WRONG

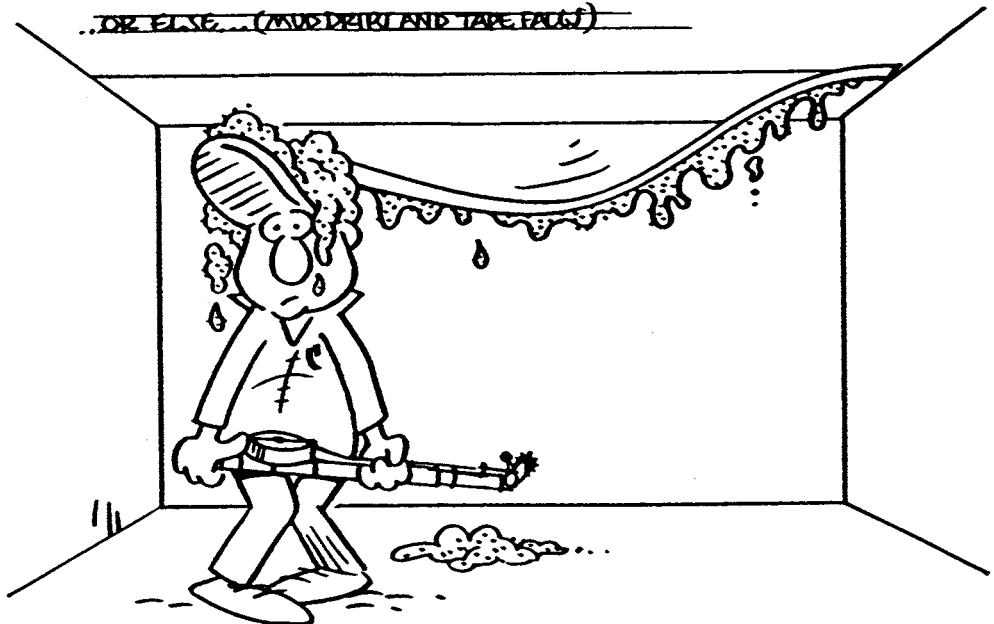

Butt Joints

PROCEDURE FOR TAPING BUTT JOINTS

Put both wheels of Taper on the wallboard at the beginning of the joint. Roll the wheels forward simultaneously pushing the CT#126(handgrip), advance the taper. Thus the tape and joint compound will feed together. Pre-run approximately 3 inches and then run the rest of the butt joint. For lower butts, push down with your left hand and with the right hand acting a fulcrum, bring the head of the machine up the joint.



Vertical Angles

PROCEDURE FOR TAPING VERTICAL ANGLES

Put both wheels of the taper on the wallboard at the beginning of the joint

Roll the wheels forward simultaneously pushing the CT126(handgrip), advance the taper. The tape and joint compound will feed together.

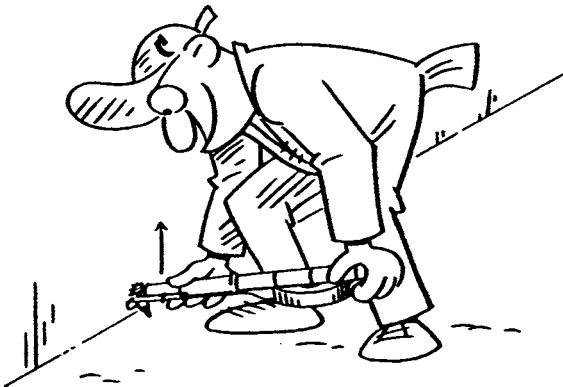

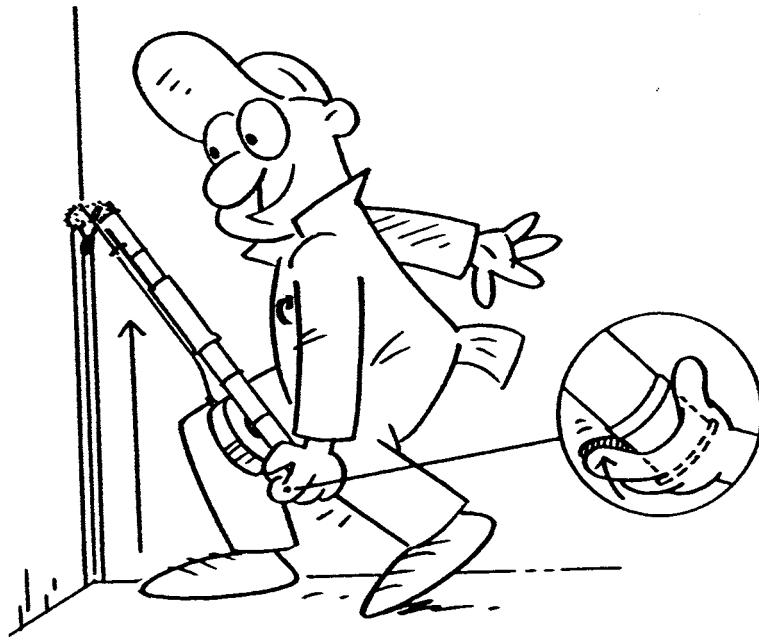

Procedure for holding the Taper while taping Vertical angles

Here is a check to see if you have the correct holding position when taping a vertical angle: once the head is pointing toward the ceiling you should be able to remove your right hand. The Taper should stay in the angle with only your left hand pushing it. This demonstrates the fact that your right hand is only a support, and should not be used to apply pressure on the head.

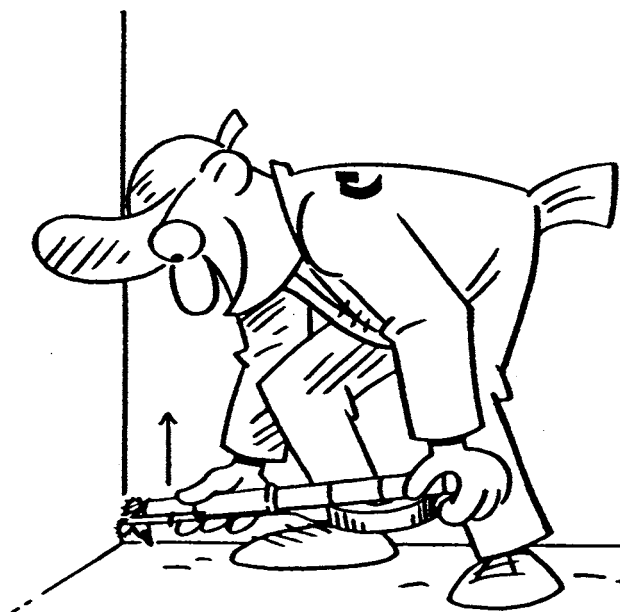

THE DREADED 3-WAY



3-Way Angles

PROCEDURE FOR TAPING 3-WAY ANGLES

There are several ways to start a 3-way angle. A common complaint is getting a blank spot with no joint compound 6" after you start. This can be minimized by: a. Priming the Taper on the wall up near the 3-way angle for 4-5" before you eject any tape. b. Eject tape once. c. Push the Taper in corner simultaneously pulling tape and joint compound until there is enough that the crimping wheel can get underneath. Pull taper out of corner with 4-5" dropped or supported by crimping wheel. Move taper into 3-way angle, slapping tape into corner, leaving 1 to 2" excess allowing for drag. As you master the taper, you'll need to leave less and less excess. As a rookie you might need a helper to hold tape in the corner with a roller until you master it.

Note: These are basic taping machine procedures. With experience you will develop your own style from these basics.

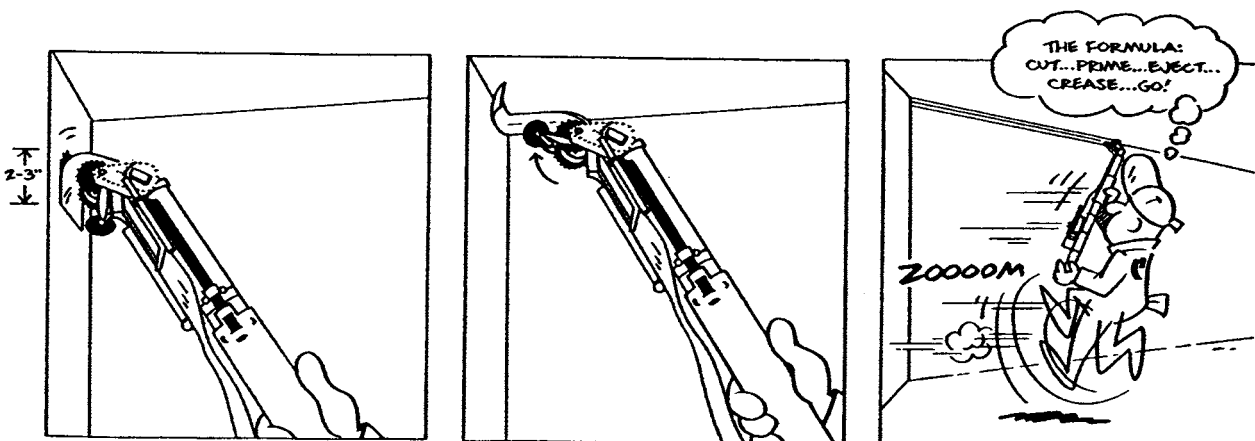

Rinsing Machine Head

Whenever the machine is stopped for five minutes or more place the head in a pail of water to prevent joint compound from drying and jamming the moving parts. Even when the machine is in use, periodic dousing of the head in water is a good idea. Before immersing the head:

1. Remove the tape from the head because it gets soft when wet and will tear when the needle tries to pull it through. Wet, soggy tape will jam the cutting blade.
2. Close the mud gate CT# 93 that holds joint compound in the tube. (Also close this mud gate whenever setting down the machine headfirst.) The closed mud gate will prevent joint compound from leaking out and thus the plunger from sliding down the tube without the cable winding up. If this should occur the slack cable could become tangled and break when the machine is filled again.

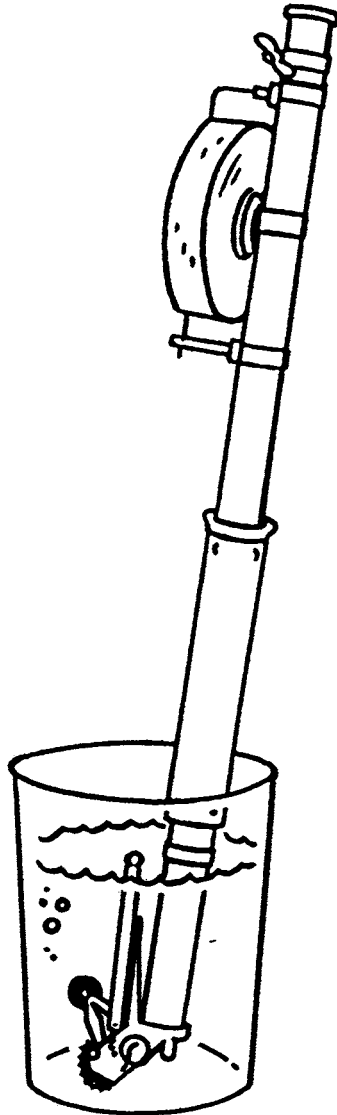

Short tapes

Short tapes can be applied two ways: direct from the machine, or cut from the machine and put in place by hand. Putting them in place by machine is cleaner and faster; hand application is more accurate. To apply short tapes by hand, turn the winding key on the left so that the joint compound and tape are pushed out. Remember that when 1" of tape shows, 3" will be the cut length of tape. It takes practice to cut tapes the right length. Short tapes around pipes should be left for the wiper to place so that they are a tight fit.

An alternate method is to run off the length of tape required, then rip it off against the plate above the wheels. The length will be more accurate but the cut will be rough.

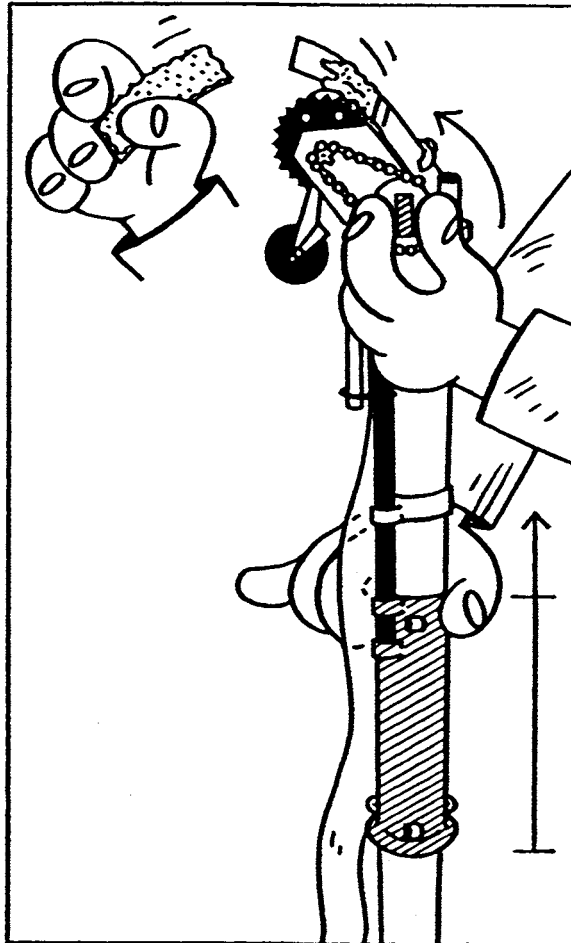

Minimum Stress Techniques

The Taper considerably speeds up the taping process; but without using proper body form while holding the Taper its use can shorten the working life of drywall finishers. Muscles and joints are attuned to the length of the limbs. When a taping machine is used, it extends the length of the arms and in so doing puts stress on the arm muscles and the joints of the back. ***Therefore the Taper must be held correctly with the body in the right position to minimize stress.

Drywall finishers in general are susceptible to elbow, shoulder, and back problems. Using the Taper with ***improper techniques*** will cause injuries that will further reduce a drywall finishers working life. Columbia Taping Tools would like to see our customers work life protected as well as life after work. Please use proper holding techniques when using these machines.

One of the problems with the machines is the speed. There is a tendency for the operator to maintain the speed even in situations where the use of the machine is not feasible, for example, where it is necessary to stretch or bend the back. While the Taper may only weigh 55 lbs. when full, the force it exerts is multiplied the further it is used from the body. Know the limitations of your body: do not exert needless and ultimately damaging strain on yourself. In addition before you begin it may be a good idea to stretch and warm up the parts of the body involved in the use of the Taper.

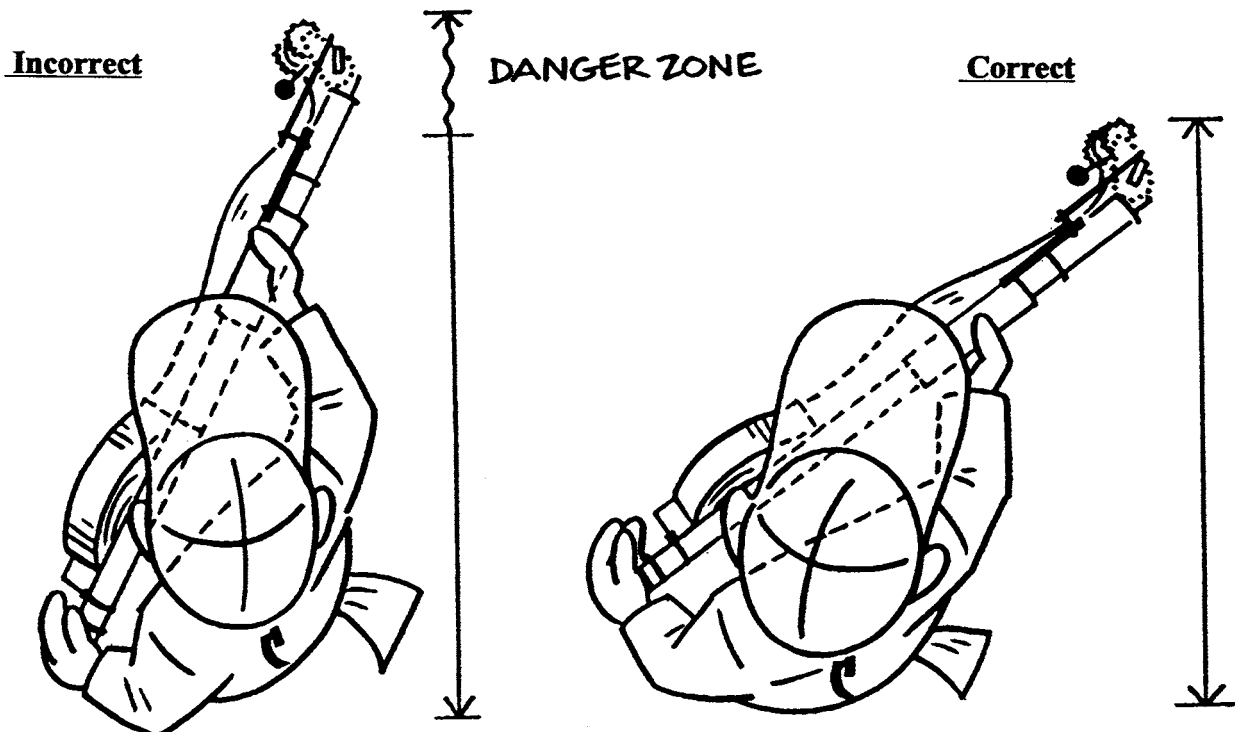

Helpful Hints for Taper Use

1. The horizontal angles between the wall and ceiling are the most difficult to tape. The key to keeping the tapes straight and on the angle is to hold the machine so that it bisects the angle: otherwise one wheel will run the tape to the side of the angle, resulting in the tape dragging along the angle until it falls off. When a tape goes off-center extra effort must be exerted to keep it in the angle by applying pressure with the right hand. However, this only accentuates the problem because the pressure you apply with your right hand the less you apply with your left hand. With this grip the machine will twist, causing the head of the Taper to jump from side to side in the angle.
2. Take care when cutting tape at three-ways. There is little tolerance, as you must put tapes tight into three-ways so that they form square angles when wiped.
3. It is important to make sure that the ends of the tape on flat and butt joints are firmly pressed to the board with the crimping wheel. If this is not done the ends will start to peel off and, if not caught, the whole tape will fall off.
4. As with the hopper method of taping, run the tape right across any light boxes occurring along a ceiling joint.
5. You can tell when a Taper is running low on joint compound by a whooshing sound. When you hear it, the tape will be dry in about another 2".
6. Do not drop the bottom end of the machine on the floor when it is still more than half full, since the plunger will have a great deal of weight on it from the remaining joint compound and the sudden jar may break the cable. Replacing the cable is a time consuming procedure.

THE CLOSET CAPER

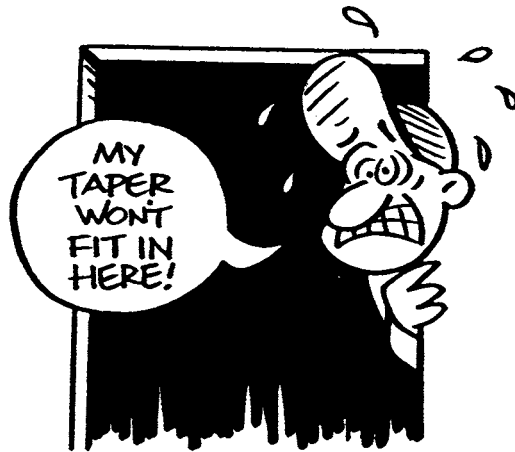

Taping Closets

Closets give rise to special taping problems. Usually closets are not deep enough to enable you to tape the front angles in the normal way. The front vertical angles have to be taped by stripping the tape off the Taper and putting it into the bottom of the angle by hand. Set the machine on the floor so that the head of it points toward the ceiling. Unwind about 1" of tape and joint compound from the machine and then pull the tape down to the floor with your left hand. Use index and second fingers of your right hand to form a brake as the tape slides through them. Pull out enough tape so that the machine can be pushed up the vertical angle

The horizontal angle at the front of the closet also cannot be taped normally because you cannot angle the machine enough to get one of the wheels on the wall. Only the wheel closest to the ceiling will touch. Leaving adequate overhang to account for the increased drag put the tape into the three-way and pull the machine along the angle. Snap the creasing wheel into the angle as far as it will go, but note that because of the angle, at which the machine is being run, the tape will not have much of a crease. The wheel just makes sure that the tape stays up. To move the machine, lean back and use your arms to push and pull it above your body. You will not be able to cut the tape to the right length, so allow enough room at the end of the angle to run it out of the Taper and make the cut. After cutting the tape use the creasing wheel to push the tape into the angle so it doesn't fall off. Leave to the wiper the task of getting the tape centered in the angle.

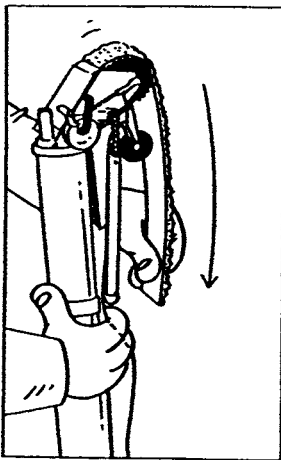

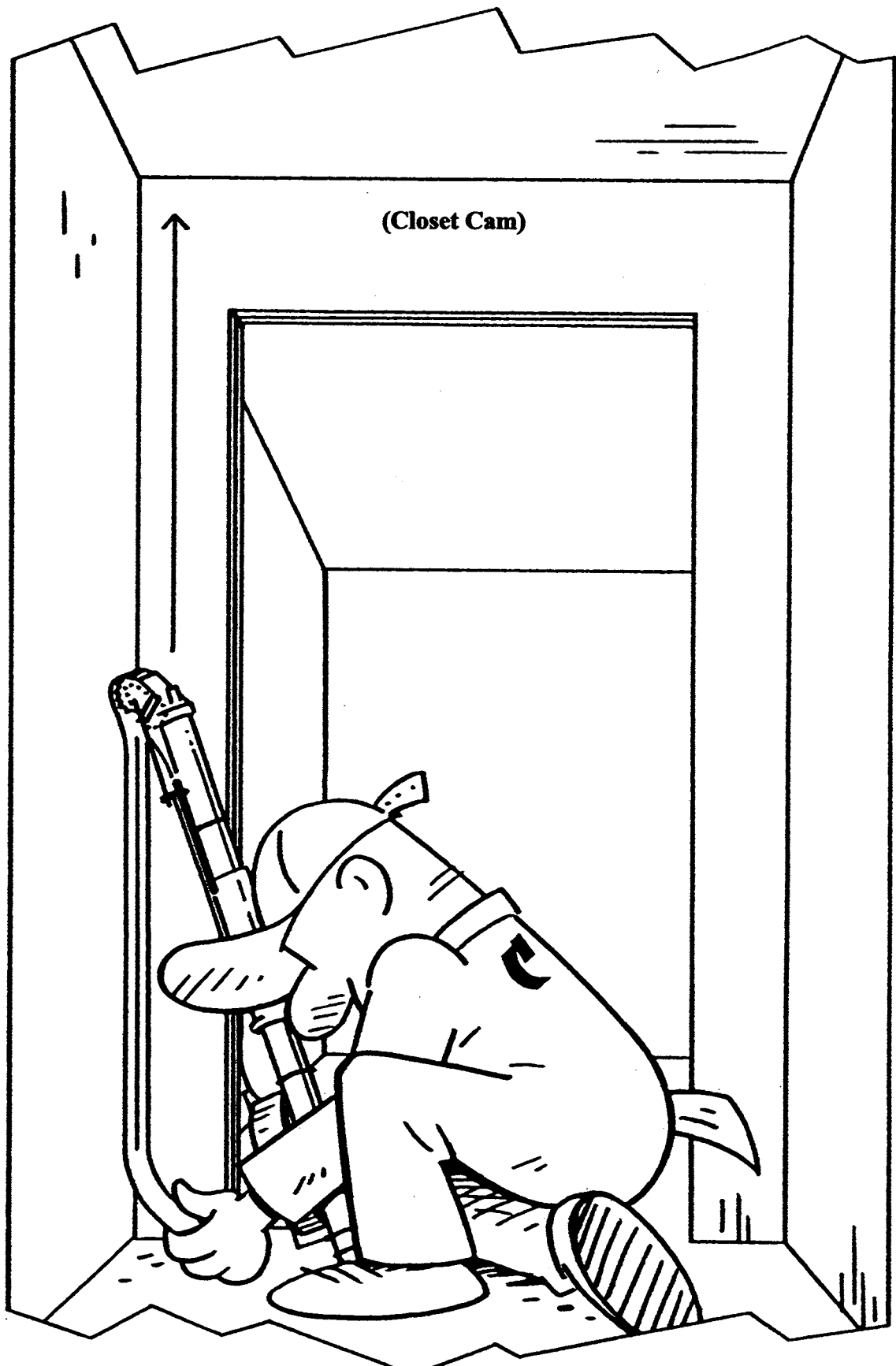

Taping Etiquette

Because it is very easy for the tapers to get ahead of wipers, certain rules of etiquette apply in order to maintain harmony between the two. Taping is teamwork; the better the team work the greater the production.

- If a dry tape is left at the end of a joint let the wiper know that the tape is dry and peel the tape back to where the joint compound stopped. Avoid leaving dry tapes longer than 10".
- Concentrate on cutting the tapes the right length. If they are long or short, the wiper will have extra work and get behind.
- If two tapes are put on the same joint let the wiper know so that the method of wiping can be adjusted accordingly. If two tapes occur along a vertical angle overlap the higher tape and bring this to the wiper's attention.
- If more than two tapes are used in one place, as in the case of the electrical outlets or in covering a hole, have the wiper wipe them as you apply them.
- If plastic sheeting is found in an angle have the wiper cut it out, since it is easier to cut out the plastic when it is not covered with joint compound.
- Check with the wiper to make sure the joint compound is not too thick or too thin.
- Make sure the wheels do not skip and leave a dry spot under the tape on the ceiling joints because they are very difficult to reach from the floor.
- Place something under the end of the pump gooseneck to catch any joint compound that runs out when loading the Taper.
- Put the pail and pump where they will not hinder you or anyone else's movement, i.e. away from walls, the doorway, and not under ceiling joints.
- Keep the machine clean at all times. I.e. rinse periodically while running.

Cleaning the Taper

1. Remove excess joint compound from the tube:
 - Hold Taper horizontal with the head over a pail
 - Open the gate CT#96
 - Turn the CT# 80 Manual Drive Grip and empty joint compound into bucket

2. Rinse Tube:
 - Close gate
 - Fill Taper with water through filler valve CT# 97
 - Shake the Taper back and forth a few times
 - Open gate CT#96 with the gate lever CT# 93
 - Turn CT#80 Manual Drive Grip until all water comes out and the plunger body CT# 107 disengages the CT#83 Clutch Dog and closes the gate.

3. Removing joint compound from behind the mud gate CT# 96
 - Close the gate further
 - Fill the Taper ¼ full with water.
 - Turn the Taper upside down a few times so joint compound can be removed behind gate.
 - Open the gate and turn the CT#80 Manual Drive Grip until the water is removed from the tube and the plunger closes the gate once more.
 - Repeat this process again or until the water becomes clear.

4. Wash all outer parts of the taper with a hose and/or brush and water
 - Be sure to spray water into the end of the taper tube to remove any residue of compound.

5. Before putting Taper away, be sure to wind the cable up on the drum by turning the CT#80 Manual Drive Grip until plunger closes gate.
Lubricate all moving parts with a silicone spray.

Taper Troubleshooting

<u>Problem</u>	<u>Cause</u>	<u>Solution</u>
<p>Joint compound will not go into the Taper</p>	<ol style="list-style-type: none"> 1. No joint compound at pump entry port. 2. Pump not primed 3. Entry port of pump plugged 4. Dried joint compound at exit port of pump 5. CT#101 spring in CT#97 joint compound valve plugged 6. Mud Gate on Taper is not in fill position 7. Plunger mechanism jammed 8. Taper is full 	<ol style="list-style-type: none"> 1. Fill pail with joint compound or scrape compound toward entry port on pump 2. A. Put the pump in water and use short strokes on handle until water pumps through 3. Remove pump and clean entry port; remove screen if present but do not replace. Re-mix joint compound 4. Soak exit port to soften joint compound and clean 5. Remove valve, soak in water, then clean spring thoroughly 6. Push Mud Gate lever to fill position 7. Take Taper apart and remove the seizure. Check cutter chain for binding with CT#80 Manual Drive Grip. Check cable to make sure it was wound properly
<p>Filler valve CT#97 Leaks</p>	<ol style="list-style-type: none"> 1. Something stuck between valve and seal 	<ol style="list-style-type: none"> 1. Use a nail to tap on valve to dislodge foreign material 2. Remove filler valve and clean

<p>Joint compound does not flow onto tape</p>	<ol style="list-style-type: none"> 1. Mud Gate CT#93 not open 2. Cable CT#72 broken 3. Dirty head 4. Drive wheels CT#67 not turning 5. Drive Chain broken 6. Clutch Release Rod CT#88 has not returned to working position 	<ol style="list-style-type: none"> 1. Pull CT#93 Mud gate lever all the way up 2. Push plunger body CT#107 from end of machine and replace cable 3. Soak head and remove solidified joint compound 4. <ol style="list-style-type: none"> a. Make sure drive wheels are contacting board b. Remove dry joint compound that may be binding wheels, by soaking head in water c. Check drive chain for breakage d. Check tension on drive chain. If too loose, tighten with chain tightening guide or replace 5. Replace chain 6. Push Release Rod back
<p>Tape drags along joint</p>	<ol style="list-style-type: none"> 1. Joint compound too thick 2. Too much pressure on drive wheels CT#67 3. Tape not properly started 4. Head of Taper is not parallel to the joint 5. Tape not feeding through machine freely 6. Crimping wheel pressing too hard 	<ol style="list-style-type: none"> 1. Thin joint compound to proper consistency 2. Relax more, exerting only enough pressure to make wheels turn 3. Both wheels should touch wall for first 6 inches of joint 4. Turn head so that drive wheels are parallel to joint 5. Clean CT#19 feed guide and soak head 6. Relax pressure on crimping wheel lever CT#105
<p>Tapes falling off joints</p>	<ol style="list-style-type: none"> 1. Tapes dragging along joint 2. Joint compound too thin 3. Ends of tape not pressed against wall 4. Tape cut at electrical outlets 	<ol style="list-style-type: none"> 1. See solutions above 2. Thicken Joint compound 3. Press ends of tape against board 4. Run tape over outlets

Tapes too long	<ol style="list-style-type: none"> 1. Not cut soon enough 2. Handgrip CT#126 not pulled back far enough 	<ol style="list-style-type: none"> 1. Sight along the joint compound valve to the end of the joint, then cut 2. Handgrip should be pulled all the way back in cutting position
Tapes too short	<ol style="list-style-type: none"> 1. Tape dragging 2. Tape cut too soon 3. Lack of overhang when joint started 	<ol style="list-style-type: none"> 1. See "tape drags along joint" 2. Sight along the joint compound valve to the end of the joint, then cut 3. Overhang should be left when starting any joint
Drive wheels won't turn	<ol style="list-style-type: none"> 1. Dry joint compound in head 2. Drive chain stiff or jammed 	<ol style="list-style-type: none"> 1. Soak machine head in water and wash off excess joint compound 2. <ol style="list-style-type: none"> a. Oil drive chain and drive wheels after every shift b. Check tightness of chain and adjust c. Check for CT#55 carriage guide rod jamming chain
Tape won't cut	<ol style="list-style-type: none"> 1. Blade broken 2. Blade jammed 	<ol style="list-style-type: none"> 1. Replace blade 2. Clean cutter block tube CT#25
Tape won't cut square	<ol style="list-style-type: none"> 1. Machine not stopped when tape is being cut 	<ol style="list-style-type: none"> 1. Stop Taper before cutting tape
Tape won't easily pass through head	<ol style="list-style-type: none"> 1. The Tape feed-needle is catching tape 2. Dry joint compound in tape-feeding guide CT#19 	<ol style="list-style-type: none"> 1. Set tape feed needle so that it is clear of tape when hand-grip is pushed forward 2. Soak head of machine in water and clean tracks
Tape won't pass through head at all	<ol style="list-style-type: none"> 1. Blade jammed in track 2. Piece of paper caught in paper feed guide 	<ol style="list-style-type: none"> 1. Pull blade to one side and let it snap back 2. Use hook to pull paper out of track

Tape cannot be advanced with hand grip	<ol style="list-style-type: none"> 1. Tape jammed in head, causing needle to tear tape 2. Advancing needle is not deep enough 3. Advancing needle not touching tape when Hand Grip in neutral position 	<ol style="list-style-type: none"> 1. Use hook to pull out jammed paper 2. Set needle with handgrip in neutral position so that needle penetrates tape by 1/16 inch 3. Set Carriage Cam CT#32 on right side of head so that needle is pushed down into tape when handgrip is in neutral
Dry tape	<ol style="list-style-type: none"> 1. Taper is empty of joint compound 2. Drive wheels not touching 3. Cable is broken 4. Plunger safety not engaged 5. CT#93 Mud Gate lever still contacting clutch disk 	<ol style="list-style-type: none"> 1. Refill Taper 2. Maintain steady pressure on the drive wheels 3. Take machine apart and replace cable 4. Push CT#88 rod back into Taper 5. Lift mud gate lever all the way up

Taper Maintenance and Small Repairs

On the job repairs to the Taper will depend on the availability of spare parts. For convenience a Taper repair kit should be kept on hand as well as these parts: a cutter blade chain assembly, filler valve, cable, and drive chain.

Following are general repairs to the Taper that can be done on the job, listed from most common to least common:

- Cutter Blade
- Joint compound Valve
- Cable
- Feed Needle
- Drive Chain

Taper repairs that must be done at a Columbia Taping Tools repair center are:

- Worn drive wheel
- Worn plunger.
- Leaks in the gate flap or in the joints.
- Bent tube.
- Broken casting

1.Replacing Cutter Blade

The CT #42 cutter blade can be replaced by two methods depending on whether the cutting block comes out or not.

Method One

1. Pull the cutter blade chain from the left-hand side of the machine until the block holding the blade is completely out of the machine. If the block does not come out go to method two. If it does come out go to step 2
2. Use a nail or wedge to prevent the spring on the right hand side of the machine from pulling the cutter chain back.
3. Remove the screw from the block and remove the blade.
4. Place the new blade in the block so that the blade tapers off to the right..
Caution: The blade is very sharp. Do not push it into place with your fingers.
6. Tighten screw
7. Release the spring.

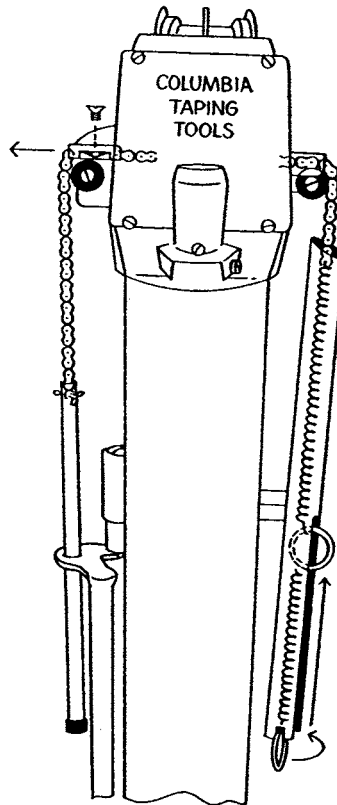

Method Two

If the blade does not come out:

1. Remove the cotter pin on the left-hand side of the cutter chain. Note that when the cotter pin is removed, the aluminum tube will fall away from the machine.
2. Pull the chain to the right to completely remove the chain from the machine.
3. Follow procedures 3, 4, 5, and 6 in Method One.
4. Feed the chain back into the machine making sure the blade is toward the top.
5. Replace the cotter pin.

Note: At times it may be impossible to remove the screw to release the cutter blade. In this case a new chain and blade block should be put in.

2. Replacing Filler Valve

The Filler valve should be replaced when it is bent and will not seal properly in the gooseneck, or when the valve will not seal during taping causing joint compound to run out of the machine.

Steps

1. Loosen the set screw on the head casting at the base of the joint compound valve
2. Using a screwdriver and a hammer, gently tap on the joint compound valve screw to remove the valve from the casting.
3. Insert a new valve using a piece of wood or plastic to seal it into the casting.
4. Tighten the screw.

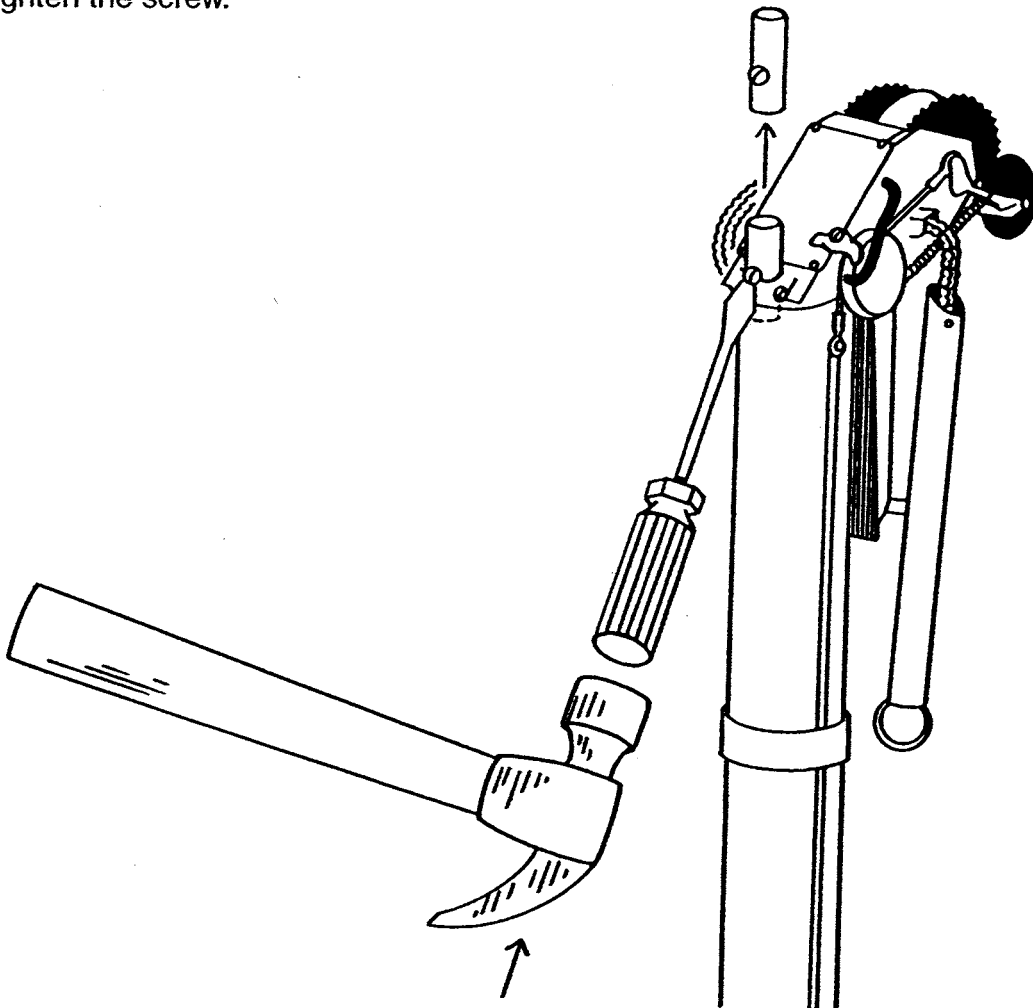

3.Replacing the Cable

Replace the cable if joint compound will not flow onto the tape when the drive wheels are turned. However, first check these more common causes for compound not flowing onto tape:

- The Mud gate lever CT# 93 is not up as far as it will go.
- The Clutch Release Rod CT# 88 is not pushed back into the head.
- The Manual Drive Grip CT# 80 does not turn freely while driving the drive wheels.

If the cause is indeed the cable then follow these steps:

1. Empty joint compound from the machine by pushing the Piston Body CT# 107 to the top of the machine with a stick.
2. Remove the four screws that hold the Cover Plate Cap in place.
3. Remove the Cover Plate Cap.
4. Unwind the Cable CT# 72 from the cable drumCT# 73.
5. Remove the setscrew that holds the cable in the drum and pull the cable out.
6. Remove the Guard Ring CT# 115 at bottom of Taper.
7. Remove the piston with either a stiff piece of wire or by shaking the machine up and down.
8. Remove the Cable Retaining Nut CT# 114 on the top of the Piston Body
9. Remove the cable
10. Thread the new cable through the removed nut and through the slot in the bolt.
11. Place the nut on the bolt and tighten it so that the cable is secured to the piston and the brass end of the cable is beyond the nut
12. Load the cable into the end of the machine and fit the piston into the tube. Be certain that the seal of the piston does not fold over.
13. Push the piston to the end of the machine.
14. Pull the cable through the head.
15. Place the brass ball on the end of the cable into the slot on the cable drum
16. Place the retaining screw in the drum and tighten it. Use a test pull on the cable to make sure it is secure to the drum.
17. Using a screwdriver or a piece of wood, pull the cable tight.
18. Put the Mud Gate Lever down so the drive wheels are disengaged.
19. Wind up the cable making sure it does not twist or bind.
20. Replace the cover plate. Be careful not to cross thread as they strip and break easily.
21. Replace the Guard Ring CT# 115

SEE DIAGRAM ON PAGE #38

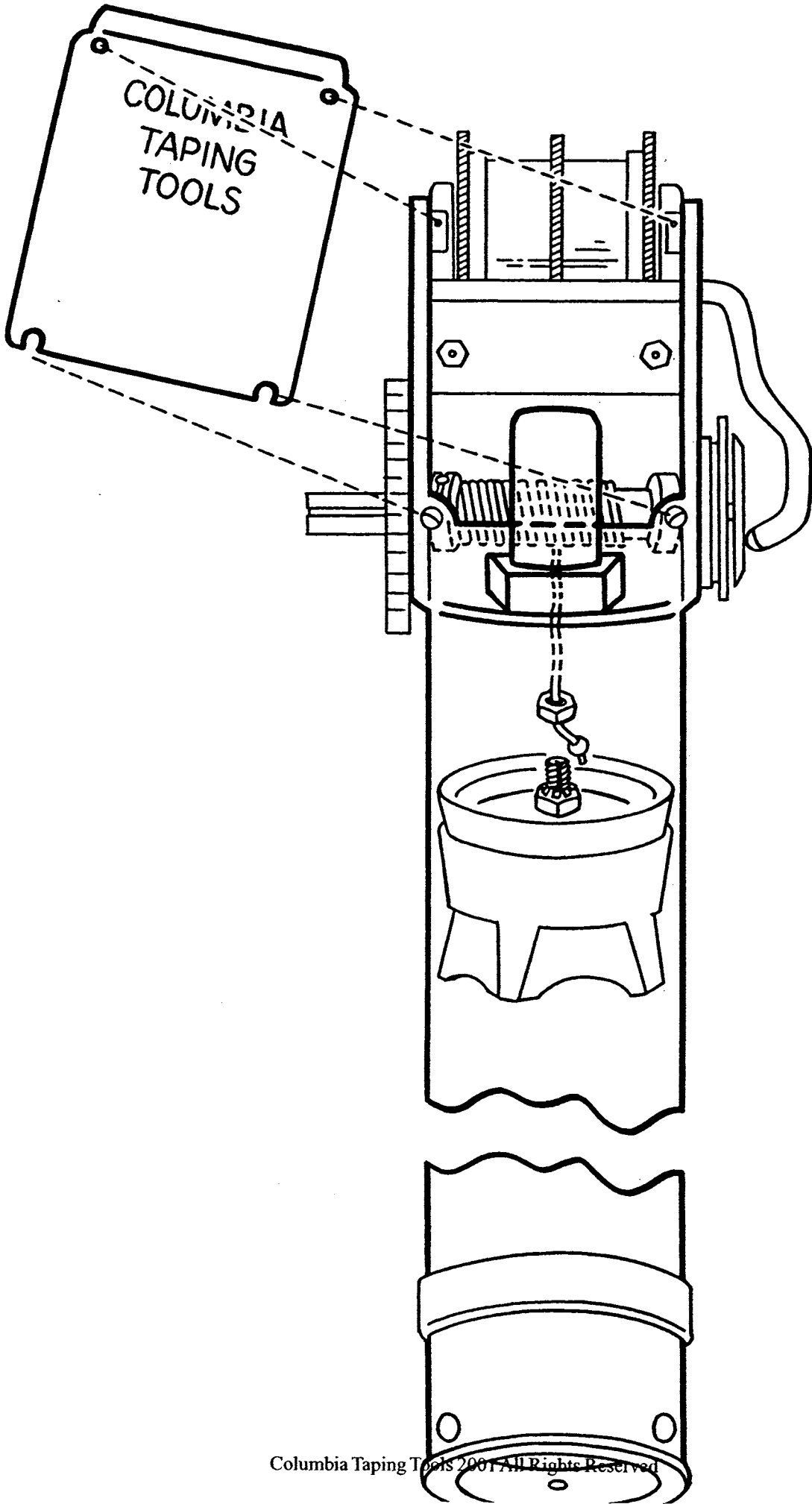

4.Replacing Tape Feed Needle

The tape feed needle CT# 63 is not replaced very often but it may wear down or fall out.

1. Remove the CT# 140 screw
2. Pull the needle out.
3. Put a new needle in place and adjust it so that it penetrates through the tape with the needle at mid-point in the advance position.
4. Tighten CT# 140.

5.Replacing Drive Chain CT# 78

Extra drive chains are not normally supplied with the Taper and must be purchased separately. It is a good idea to have a spare one in order to keep production flowing smoothly.

To replace the drive chain:

1. Remove the chain guide CT# 31.
2. Push in the CT15 Ratchet Rod just below the drive wheels CT# 67.
3. Roll the drive wheels backward while holding the small sprocket CT# 71 and the Drive Chain CT# 78 with a pair of vice grips and the small chain sprocket CT# 71 will unscrew from the drive wheel shaft CT# 70.
4. Remove the old chain and put the new one in place.
5. Put the small sprocket into the chain and place the sprocket on the shaft.
6. Roll the CT# 67 Ratchet Gears (or Drive Wheels) forward until the sprocket is tight.
7. Release the Ratchet Rod.
8. Install the chain guide.

Part 3

The Columbia Flat Boxes

Introduction

The advantage in flat box use for butts and horizontal joints is the speed with which joints can be filled. When the machines are set up and run properly only a minor touch-up is required. Some finishers, however, insist on going over the joints with a knife or trowel to smooth the joint compound left by the boxes. This is a poor practice because it defeats the time saving advantages of the machines. If the machine filled joints have to be completely gone over by hand, the machines are not being run properly.

Columbia Flat Boxes

Flat boxes come in 4 sizes –7", 8", 10", and 12". The 12" box is used only for finishing; the 7", 8", and 10" are used for loading coats. These boxes are aluminum with a hinged back to which a handle is attached. The handle is used to apply pressure, which causes joint compound to spread onto the wall. The leading edge of the box has wheels on a pivoting axle, which enable the box to run easily along the wall. The trailing edge of the box has an adjustable finishing blade fixed on a sectioned brass bar. The blade should have slight bow in it so that slightly more joint compound is left in the center of the fill than on the edges. Just above the bar is an adjuster dial FFB# 12 that puts pressure on the bar in order to regulate the amount of joint compound being dispensed. It is important that the joints be lightly sanded before filling to prevent the finishing blade from picking up any dry material and causing scratches.

Preparing the Flat Box for Use

Before using the boxes soak them in water to soften any material inside. The handle is attached to the box by sliding the wing nuts on the back of the box into notches of the handle and tightening them. The brake lever should be tested and adjusted to the liking of the operator. This can be done by adjustment of the socket head screw FFH# 26 that contacts the Friction brake disc FFH# 5 on the handle. The blade, when correctly adjusted, should be slightly above the shoes FFB# 7 and 7A at each end of the box. If the blade is too high it will remove too much joint compound and could cut into the board; if it is too low it will not feather the edges. To test the height of the blade, pull your fingernail across the blade at the shoe FFB#7 and 7a. Your fingernail should just catch the blade. To make adjustments turn the screws at the end of the blade. Push down on the end of the blade to make sure it is tight against the screw and that it is properly adjusted. The screw should turn easily so that any piece of flat metal will turn it if a screwdriver is not handy. While checking the blade height, also make sure the blade is free from nicks and burrs and that the edge of the blade is square. If you find that a blade will not feather properly and cannot be adjusted to do so, replace it with a new one. To adjust the amount of joint compound dispensed by the box, adjust the cam above the blade. The higher the cam number, the more pressure there is applied to the bar and the less compound there is left on the joint.

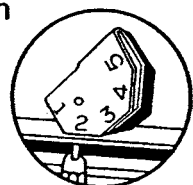

Loading a Flat Box

Flat boxes are filled using a Columbia Mud Pump. The pump must be clean on the inside and have a screen on to prevent hard material from getting into the box and causing scratches in the joint compound. The compound must be thin enough to pump. A flat nozzle MP# 9 (standard fitting) attached to the pump by a chain is needed to fill the boxes. It is put into the outlet by wetting the rubber ring and then pushing the nozzle into place with a slight turning motion. The nozzle should fit easily into the hole; do not try to force it by hammering it.

Joint compound is pumped until it can be seen at the mouth of the box. Do not let the compound run out of the mouth as it will make the box messy and leave unwanted compound on the wall. The cleaner the box is kept the cleaner the job will be. The first time the box is filled after it is soaked in water, it should be emptied back into the pail. This will remove all the water the joint compound has picked up from inside the box. If this first box full is applied to the wall it will run off the joint because it will be too thin to stay in place.

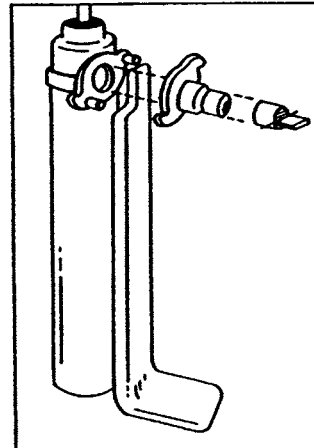
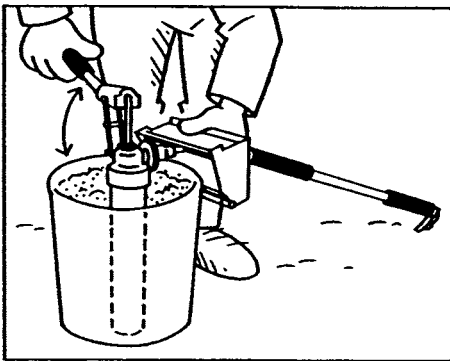

Joint Filling Combinations with the Flat Boxes

Before the first coat and between successive coats remove bumps, ridges, or other irregularities either by scraping with a blade or by rough sanding. This is necessary to prevent the finishing blade from picking up any dry material and causing scratches.

There are three combinations of flat boxes used for flat and butt joints in the drywall trade. The first combination is:

1. First coat, 7" or 8" box
2. Second coat, 10" box
3. Third coat, 12" box

This combination is used when a very good finish is required.

The second combination is:

1. First coat, 7" or 8" box
2. Second coat, 10"

Some finishers as a way of saving joint compound prefer this combination. However, the finished width of 10" is not aesthetically pleasing to the eye.

The most popular combination is:

1. First coat, 10" box
2. Second coat, 12" box

This combination is accepted as the standard in the trade; it gives satisfactory width for decoration.

Filling Horizontal, Butt and Ceiling Joints

Filling Horizontal Flat Joints

The first coat is done in one pass with the box, and some touching up is done with a knife. Place the box on the flat as close as possible to the angle. Hold one hand just below the head of the box handle and the other at the end of the handle to operate the brake. Boxes may be operated equally well left or right handed. The hand nearest the box applies pressure to force the joint compound out of the box. The elbow of that arm is braced against the body so that the arm forms a 90° angle to the wall. The other hand keeps the box running parallel to the joint. Thus the blade of the box is perpendicular to the joint leaving the compound even and feathered on both edges. The compound should be of a consistency that will not run out of the box when turned sideways, yet will not need a great deal of pressure to force it out.

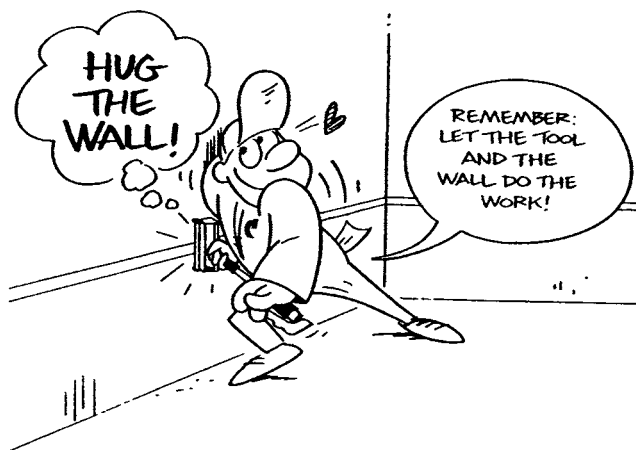
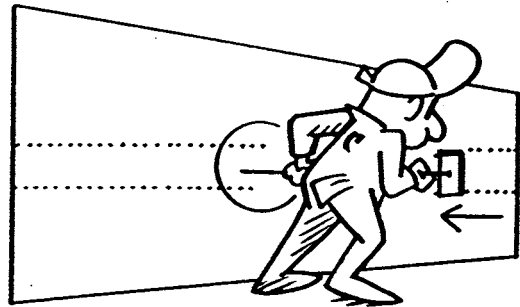
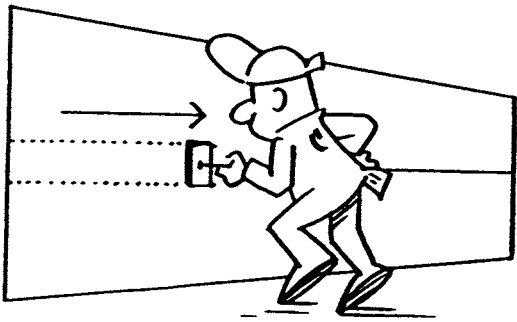

When starting a horizontal flat joint do not apply pressure too soon before moving the box, since too much joint compound will leave the box and cause a run. The pressure and the moving of the box along the joint should be almost simultaneous. As the box is pulled along the flat the bolt which holds the axle can be used to center it on the joint. By keeping the bolt in the center this allows compound to be distributed evenly on both sides of the joint. Towards the end of the pass on the flat apply the brake and gradually lift the box from the wall in a sweeping motion. This will feather out the compound and not leave a ridge. Use a knife to touch up the flat and both ends of the horizontal flat joint to leave a smooth surface. If scratches appear in the compound, wipe the box blade and check the joint for hard material. Then run the joint again until the compound is free from scratches.

When running flat horizontal joints that intersect butt joints, the amount of touch-up required, to repair damage caused by the wheels running through wet compound, can be minimized. Lift the wheel that touches the compound by applying the brake and slightly lifting one corner of the box. With practice, little or no touch up will be required.

When the 12" box is run to finish the flats, the joint compound is thinner and the setting on the box is normally one higher than that of the 10" box. This should leave a very smooth polished surface assuming that the first coat on the flat joints is free from lumps and scratches. The finishing coat should go on much faster than the first coat.

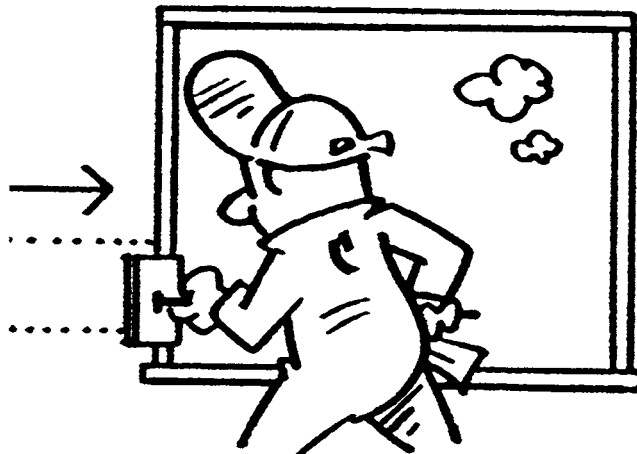

Filling Vertical Flat Joints

To run vertical flat joints the box must be more than half full. If the joint is 48" long, the box can be run the length of the joint without lifting it off the wall. If the joint is the full height of the wall it is necessary to run two passes. The first pass on a full length joint is from the bottom. With the brake on, brace the handle against your leg to put pressure on the box so that the compound flows onto the wall. By having your legs bent and then straightening them, you will be able to lift the box up the wall high enough without unduly straining your back. The bottom pass should end at least 24" up from the floor so that the pass from the top of the joint will not cause you to bend your back.

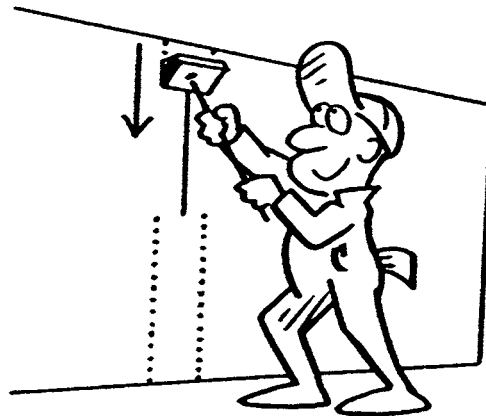

To run the upper part of the joint, place the box as close as possible to the ceiling. It may be necessary to gently bang the box against the top of the joint so that the compound will be forced out. With the brake on, pull the box down the joint until pressure keeps the wheels from lifting off the wall, then release the brake. The box will be approximately 24" from the ceiling when the brake can be released.

Filling Butt Joints

If wall butt joints are fairly level, they can be run with a box, but if they are uneven they should be done by hand. There are three methods for running butt joints by machine.

Method 1

Coat 1

1. With a 10" box, run each side of the joint with the edge of the box on the center of the tape.

While the joint compound is still wet, take a knife and skim in any exposed tape.

Coat 2

1. Same as coat 1 but using 12" box

Method 2

Coat 1

1. Run down the center of the tape with a 7" or 10" box. The tape should be just visible through the joint compound.

Coat 2

1. With a 10" box run each side of the tape (not over the tape)

Coat 3

1. Repeat coat 2 using a 12" box

Method 3

Coat 1

1. Run a 10" box down the center of the tape.

Coat 2

1. Run a 12" box down both sides of the tape (not over tape)

Filling Ceiling Joints

When running the box on the ceiling, adjust the sliding grip on the handle so that the arm of the hand nearest the box is fully extended and braced against the grip. This arm acts as a fulcrum for applying pressure with the other arm. Put pressure on the box by pulling down on the end of the handle. This feels as if you are gently wedging between the floor and the ceiling. The joint compound should not be so stiff that it will cause discomfort to your shoulder joint when pressure is applied to force the compound out of the box.

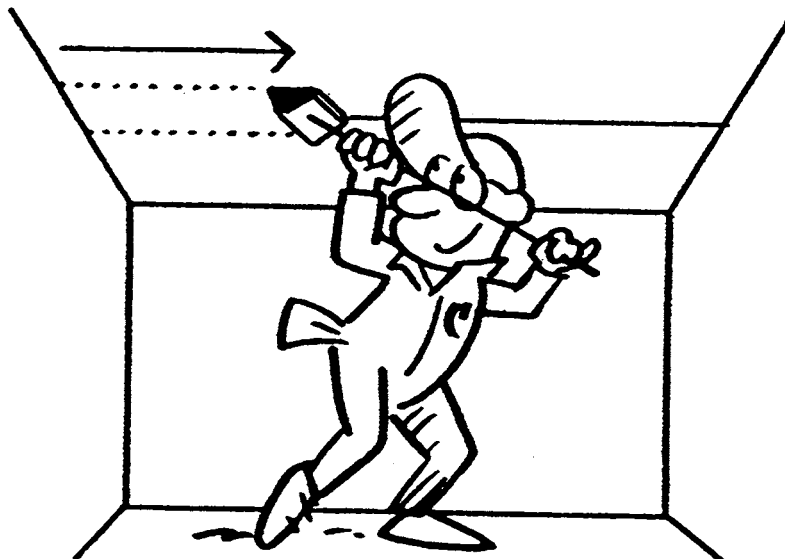

Cleaning Flat Boxes

Flat boxes must be kept clean to operate efficiently. While a good washing with a water hose will do a fair job on the flat box, to be thoroughly cleaned the back of the box must be taken apart.

First remove the FFB17 springs holding the back of the box in the upright position. Then unscrew the two FFB 32 screws that hold in the back of the box until the back comes out. Clean the box out thoroughly with a hose.

To reassemble the box, the rubber gaskets FFB# 14 should be in place with the thin piece at the pivot point. The rounded edge of the backing plate fits on at the bottom end of the box, which is the pivoting point. Wetting the rubber parts makes them slide into the box easier when you install the backing plate. Fasten the screws at the sides to hold in the back and hook up the springs. Store the box with the tension cam in the "O" position so that all pressure is taken off the blade. It is a good idea to oil the wheels and the blade adjusting screws at this point so the box will be ready when needed.

Troubleshooting

Maintenance and Repair for Flat Boxes

Changing the Blade:

Tighten the adjustment screws on each end of the box bar. Pop the blade out, if necessary use a screwdriver. Use the old blade to clean out any debris from the blade bed. Now loosen the adjustment screws so that they are flush with the bottom of the blade holder. Bend the new blade so that it is slightly bent at each end. Note: the bend will keep the blade from falling out. Place the blade into the holder, making sure the blade is approximately a fingernail height above the box shoes FFB7,

Part 4 The Columbia Nail Spotter

The Columbia Taping Tools Nail Spotter

The Nail spotter is a machine designed to fill fastener indents (Fig. 39). It is a lightweight metal box of either 2" or 3" in size equipped with a blade, which removes excess joint compound from the area surrounding the fastener. The Columbia Nailspotter is also equipped with a skid plate, which helps keep you on a straight track and protects against blade breakage. A long handle is hinged to the back of the box.

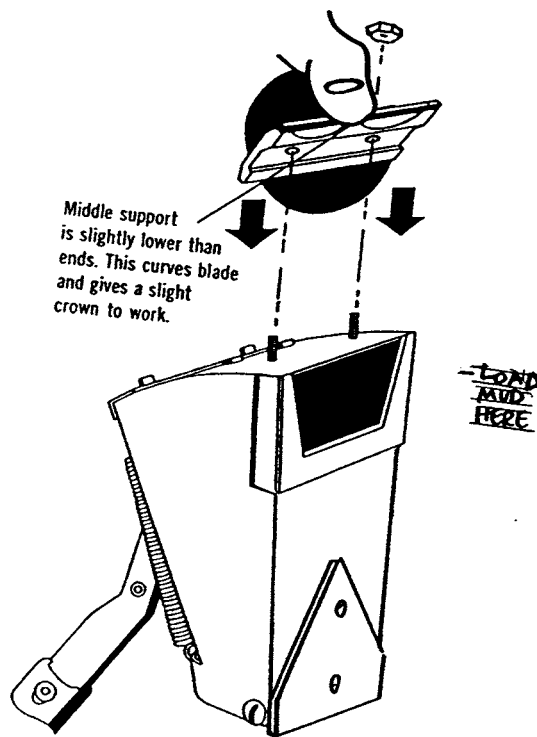

These boxes speed the process considerably as the row of fasteners can be coated in one stroke and ceilings can be done without using stilts. Note that the use of the Nail Spotter requires a good boarding job before hand because fasteners protruding above the surface of the board will chip the blade, which takes time to replace. Thinner joint compound is needed than when filling fasteners with a knife because the compound must be pumped into the box and then squeezed out onto the wall.

Loading Nail Spotter

Nail Spotters are filled in the same way as the flat boxes. Use the flat box filler spout on the pump.

Filling Fasteners with the Nail Spotter

Coat 1

1. One pass with the 2" Nail Spotter over the row of fasteners.

Coat 2

1. For textured surfaces a final pass with the 3" Nail spotter.
2. For smooth surfaces another pass with the 2" Nail Spotter

Coat 3

1. Textured surfaces do not require a third coat.
2. For smooth surfaces a final pass with the 3" Nail Spotter.

Before using the Nailspotter check the blade to make sure it sticks above the surface of the box just high enough so that your fingernail will catch on it when you pull it across the blade. Then pull the Nailspotter down over the row of fasteners. When the end of the row is reached, release the pressure from the handle and roll the Nailspotter off the wall (Fig. 40). It may be necessary to wipe off a little ripple of the joint compound at the end of the row. Only a little pressure is needed to force the compound out of the box. If you push too hard while the box is not moving, joint compound may be forced out of the box and need wiping with a knife. The box should be moving when pressure is applied. Nailspotters are held in the same way as the boxes for flats and butts.

When scratches appear in the compound, check the blade for grit and redo the fastener. Keep the trailing edge of the blade free from excess compound to ensure a smooth feathered edge. The cleaner the box is kept during the filling process the cleaner the job will be.

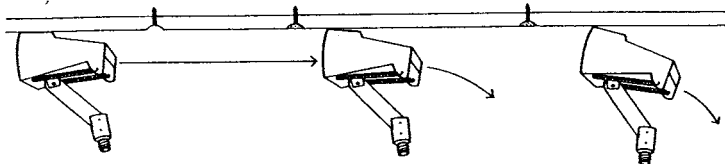

Cleaning

To clean Nail Spotter, the box should be taken apart to remove all joint compound from inside and along the blade.

Maintenance and Repair for Nail Spotter

Blade Replacement:

The Nailspotter blade may wear out or get chipped by nail or screw heads. In this case the blade needs replacement. Blades can be picked up at your Columbia Taping Tools supplier. To replace the blade, unscrew the nuts on the top of the blade clamp, lift off the used blade, and replace it with a new one. Press the blade firmly against the middle support while tightening the nuts. This will leave the middle of the blade slightly lower than the ends to leave a small rise over each depression.

Part 5

The Columbia Corner Roller & Angle Tools

Corner Roller

The Columbia roller is fabricated with a die cast head, and the pivot head adjusts to the angle of any job. After tape has been applied into the corners, the four (metal and nylon combination) rollers of this tool embed and smooth the tape while forming a sharp corner crease and forcing out excess compound from under the tape.

Press the corner roller into the corners very firmly. This ensures that the tape is pressed into the corner as far as it will go. Stand directly in front of the angle. Start in the middle of the corner joint and apply slight pressure as you work towards both ends. This will force any tape overlap to the end of the joint where it can be trimmed off. Then roll the Corner Roller back to the center. When finishing the angle between the wall and the ceiling hold the tool at 45° to the angle.

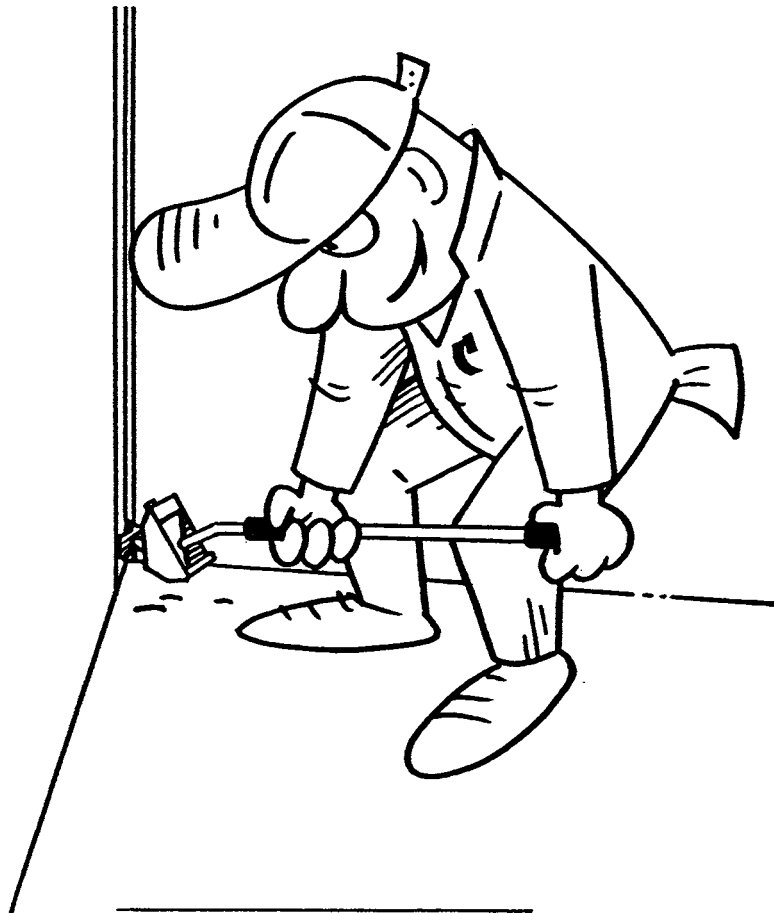

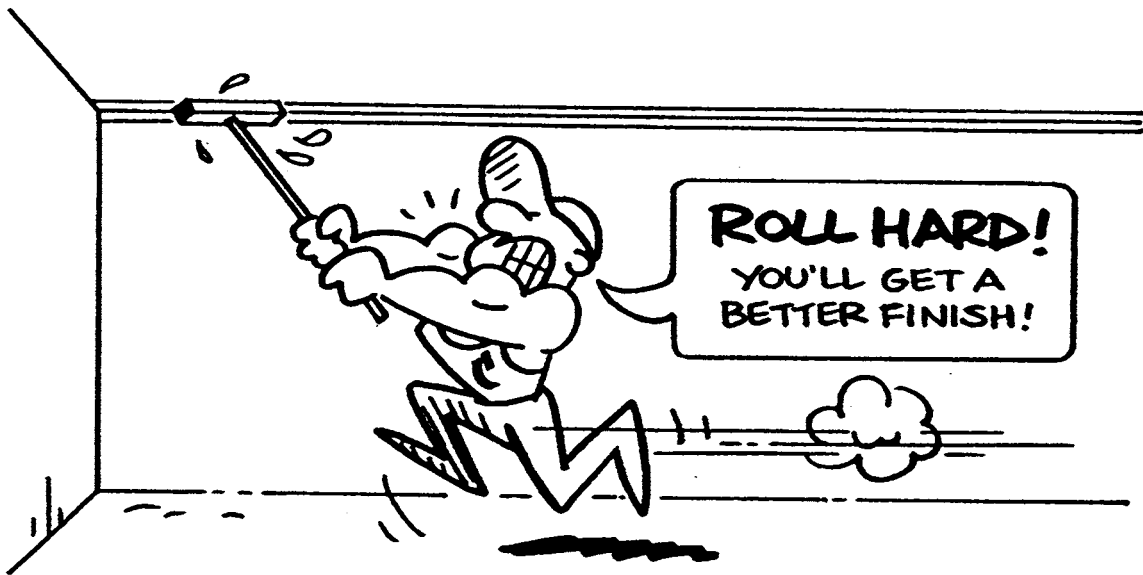
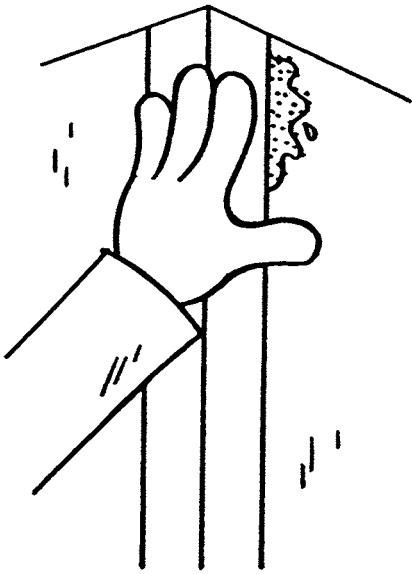

The Columbia Angle Heads 2", 2 1/2", 3"

Angle Heads are designed to fill both sides of the angle at once, leaving a more uniform finish, and they are more economical for most jobs because they are fast.

These premium quality tools utilize four blades to finish angles professionally with the correct, consistent amount of joint compound and proper feathering of the edges. These tools come with stainless steel wings, which ensure longer wear and superior performance.

The Angle Head is used after the Corner Roller to wipe away excess compound from tape embedding and feathering both sides of the angle in one pass. It is used in combination with the Angle Head handle.

The Angle Head comes in three sizes: 2", 2 1/2", and 3". The 3" Angle Head provides a good-feathered angle that is easy to sand. Its most practical use is on angles that are 90° or close to 90°. Using it on angles that are not close to 90° will result in an edge that will require feathering with a knife. The 2" finisher is frequently used by finishers but it does not feather out past the taping compound enough to make sanding easy, nor does it leave enough compound to properly coat the tape. Its best use is when angles are not a perfect 90°. New Angle Head blades may have a very sharp corner that may cut the angle if too much pressure is applied. If you are near a distributor the head should be sent back for adjustment. If not, file the point of the blade to round it off slightly. Check AH#9 bottom clip for wear at the leading end of the Angle Head so that rough edges do not occur and tear the tape.

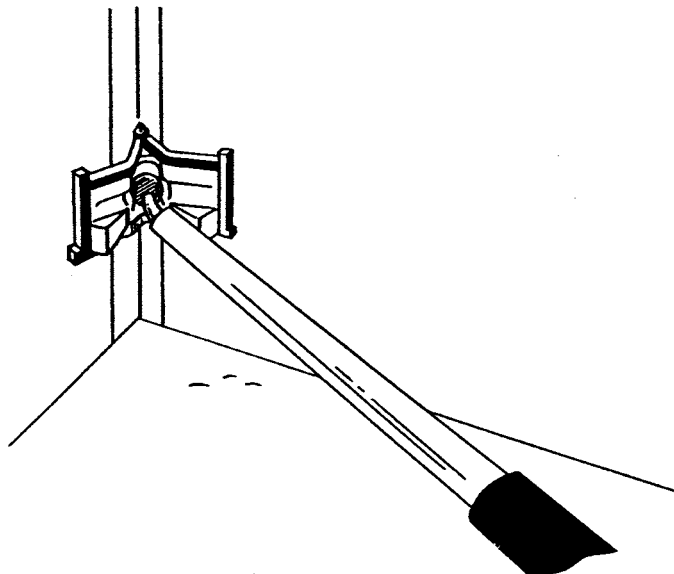

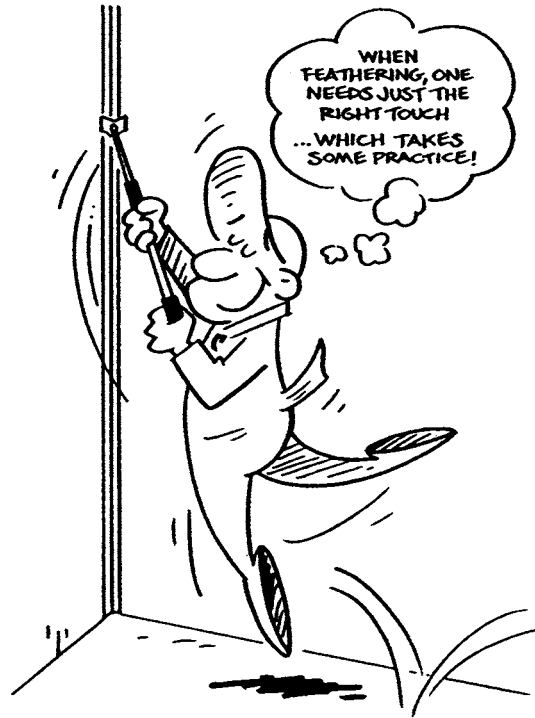

The ColumbiaCornerBox

Corner flusher boxes are available for finishing all 90° internal angles. These tools are used along with the Angle Head to apply a second coat to corners. This is one of the last procedures of the job and will cover the tape with joint compound and feather the edges of the compound onto the tape.

Columbia Corner Finisher Boxes come in two sizes. These tools are specially angled to access interior angles and tight corners. The stainless steel cone is tipped with a ball end on which the corner finisher is attached. Through this cone the corner flusher box dispenses the proper amount of joint compound smoothly and evenly. The larger box is more awkward to handle but it holds more joint compound.

Filling the Columbia Corner Box

The Angle Head snaps on to the cone ball. Before filling, corner flusher boxes with the Angle Head in place should be soaked in water to soften any dry joint compound. Placing the filler valve into the outlet of the pump fills the Corner flusher box. The filler valve is just below the cone-shaped spout and has a spring-loaded valve to prevent mud from coming out when the angle is being run. The box should be filled until the joint compound appears at the Angle Head outlet. The first boxfull of joint compound should be emptied back into the pail because the joint compound will pick up any water in the box and be too thin to use. Count the number of pumps it takes to fill the box without squirting joint compound all over the Angle Head, the floor and you. Remember the cleaner the machine the cleaner the job.

Filling Angles With the Columbia Corner Box

Some points when using Corner flusher boxes:

- If scratches appear when running a corner flusher box, check the blade for dry material.
- Keep the back edge of the Angle Head blade clean to avoid runs in the joint compound. Never run an Angle Head when the blade will encounter a metal bead edge (e.g., closet opening) or concrete scratches.

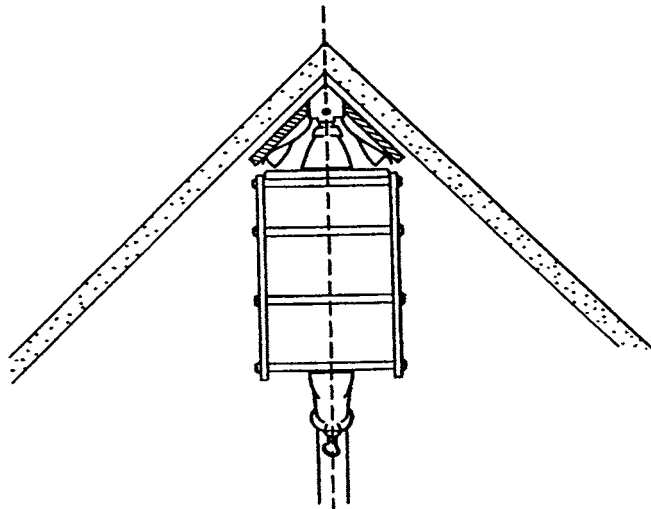

Vertical Angles

Filling angles with corner flusher boxes requires one coat, the same as by hand. Before running the box on the angles, remove bumps, ridges, or other irregularities either by scraping with a blade or by rough sanding. This prevents the finishing blade from picking up any dry material that causes scratches.

1. **The first pass** on a vertical angle should be from the bottom up to a point (about 15" to 20" from the floor) that allows easy blending with the second pass. Brace the handle against your leg to provide enough pressure to force the joint compound out; bend your legs so that when they are straightened the box will be lifted up the angle without putting strain on your back.
2. **The second pass** is made from the top of the angle down and blended with the first pass. Note: with practice it is possible to eliminate the short pass in Point 1, and run the angle top to bottom in one pass.
3. Run the angle as many times as needed to get a smooth angle with a feathered edge. However, with some angles, no matter how many times you run them, you won't be able to get a smooth finish. Indications of angles that can't be done by machine are air pockets in the surface because of the deep fills in the angle. These angles must be filled by hand.

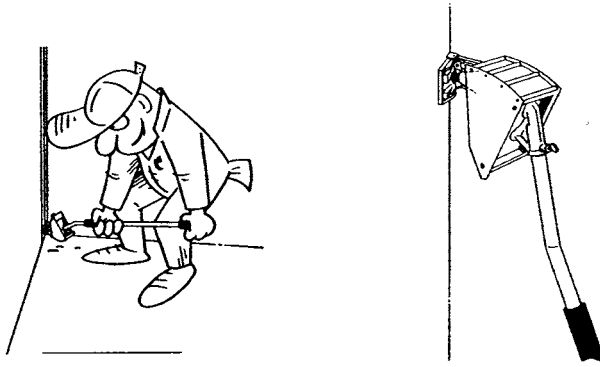

Horizontal Angles

1. Horizontal angles should be run in one motion without stopping to prevent the formation of ridges that require touching up. The pass should be as close as possible to the three-way either end.
2. Run the angle as many times as needed to get a smooth angle with a feathered edge.
3. Note that horizontal angles in closets should be done before the vertical angles so that the Angle Head can pick up any joint compound that falls into the vertical angle.

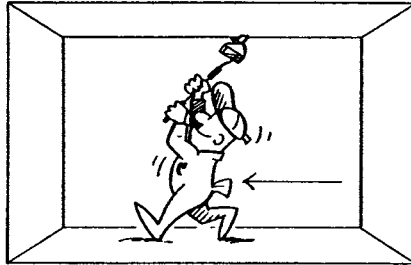

Filling Bottom Angle and 3-Way Angles

The person filling the bottoms is responsible for any edges and other irregularities in angles up to the 5' mark. The person filling the three-ways is responsible for irregularities in angles (vertical and horizontal) above the 5' mark. It is important to remove any edges and fill any scratches while joint compound is still wet. If edges are let dry they will require a lot of sanding of two or three coats of joint compound to correct them.

Bottom angles should be filled with a knife that is wider than the joint compound left by the flusher, but not so wide as to make a feathered edge that will need extra sanding.

Filling Bottom Angles

1. Add a little joint compound to the bottom of the one side of the angle and pull the knife up the angle to blend in where the box left off.
2. Feather the edge.
3. Remove the excess joint compound.
4. Repeat the same procedure for the other side, taking care not to gouge joint compound from the other angle.

Filling 3-way Angles

1. With a 5" knife apply a little joint compound to the side of the angle on the ceiling. Start with the ceiling so that any joint compound falling into the wall angle is removed when it is wiped.
2. Pull out the joint compound about 5" making sure to float over the wet joint compound on the intersecting angle and not to gouge joint compound from the adjacent angle.
3. Feather the edge.
4. Remove the excess.
5. These four passes will fill the two sides of the ceiling angle. Repeat these four passes on both walls to complete the three-way.

Cleaning Angle Tools

Angle Head

The Angle Head **must** be kept clean. Wash the outside of the Angle Head with a hose or water and a brush. **The area behind the wings must be free from joint compound. If joint compound is allowed to dry under the wings, the tips of the wings will bend and wear out prematurely.** Spray water into the opening between the wing and casting. After washing lubricate the Angle Head with silicone spray.

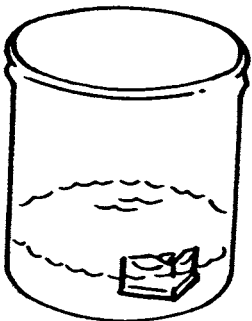

Corner Roller

Wash the Roller by spraying or brushing all joint compound from the rollers and moving parts. After cleaning lubricate all moving parts.

Corner Flusher Box

Wash in similar manner as the Flat box.

Maintenance and Repair for Angle Tools

The Corner roller has bushings that in time wear out. Repairs to roller should be done at a repair center not on the job. The same goes for the Angle Heads, due to the degree of precision required in adjusting these tools they must be repaired at a repair center.

Part 6 Repair and Parts Outlet Information

Servicing: For service you may send your tools to an authorized repair center or send your tools directly to our factory. You can obtain a location or phone number by calling us on our toll free number 800-663-8121. If you live outside North America you may contact us by e-mail elliott@columbiatools.com or at 604-532-8758.

Parts: For parts orders you must order from one of our dealers or distributors in your area or region. You can obtain a location and phone number by calling us on our toll free number 800-663-8121. If you live outside North America you may contact us by e-mail elliott@columbiatools.com or at 604-532-8758.

Warranty: All warranty issues must be first brought to the attention of the vendor of the tool. If this is not possible then you must fax a bill of sale to 604-532-7184.

Columbia Taping Tools

Phone Number 604-532-8758
Fax Number..... 604-532-7184
Customer Service #.....800-663-8121
Web address.....www.columbiatools.com
Email Address.....elliott@columbiatools.com



SLICK HAS LEFT THE JOBSITE